

T12
Geometría

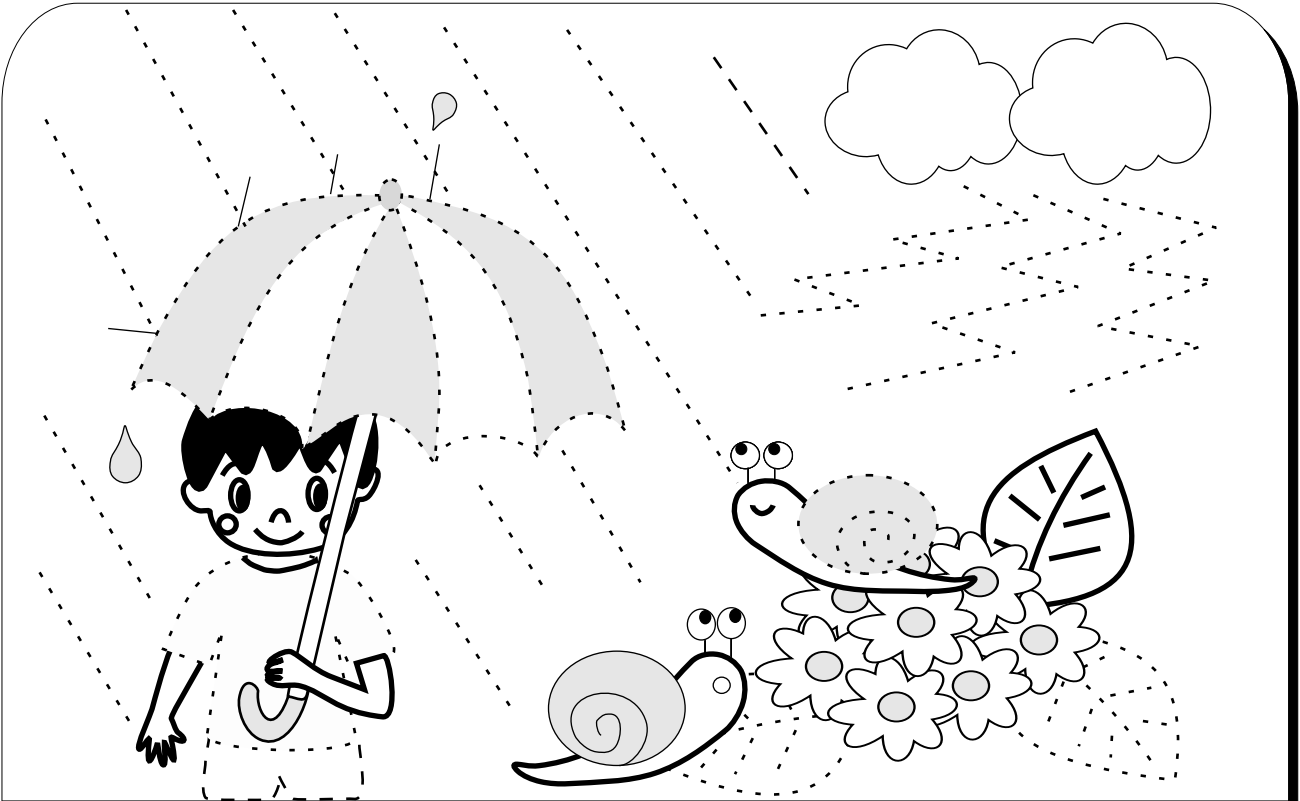



Estas son líneas rectas



Estas son líneas curvas

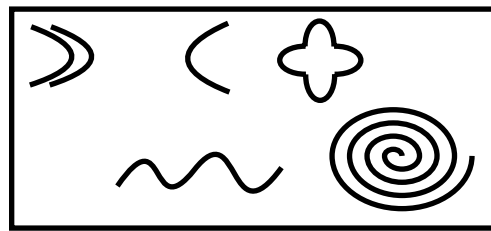

Con crayón rojo repaso las líneas curvas y con crayón azul las líneas rectas.

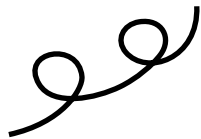

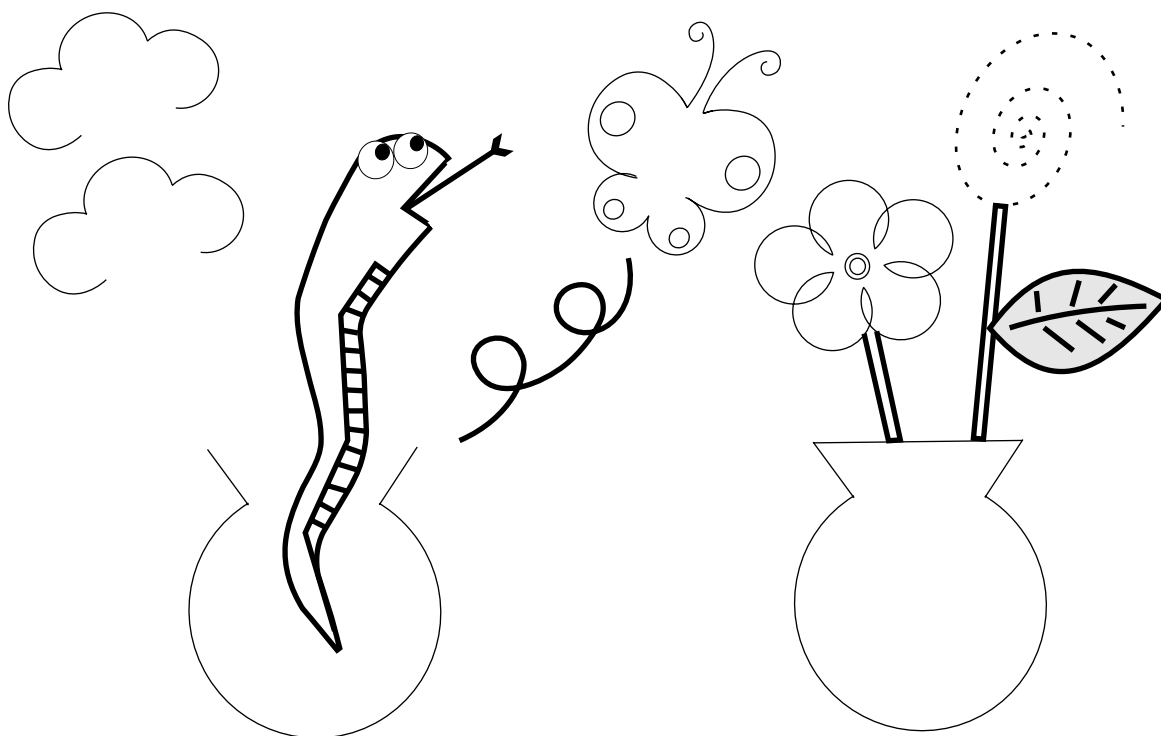

Estas son figuras abiertas.

Estas son figuras cerradas.

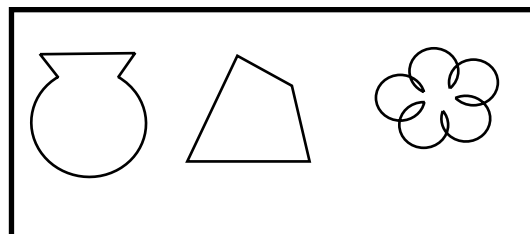
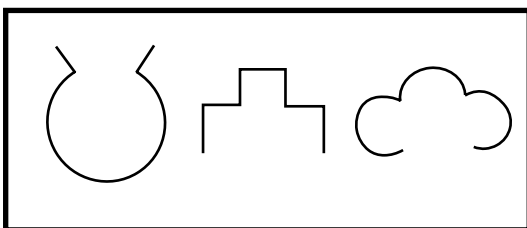

Con crayón verde repaso las figuras abiertas.

Con crayón anaranjado repaso las figuras cerradas.

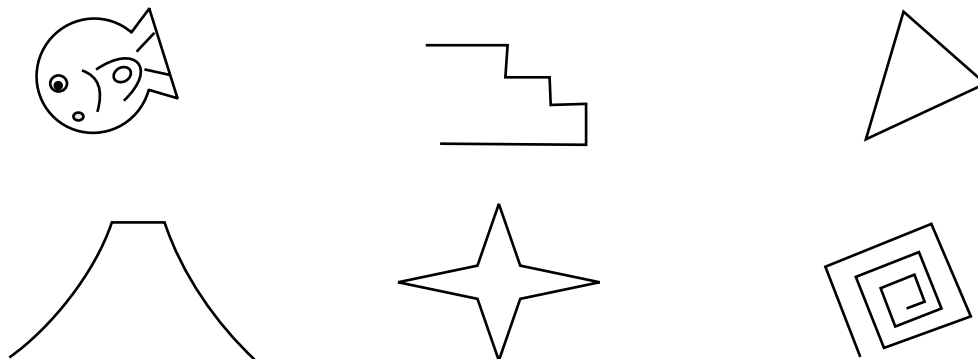



¡Vamos a jugar!

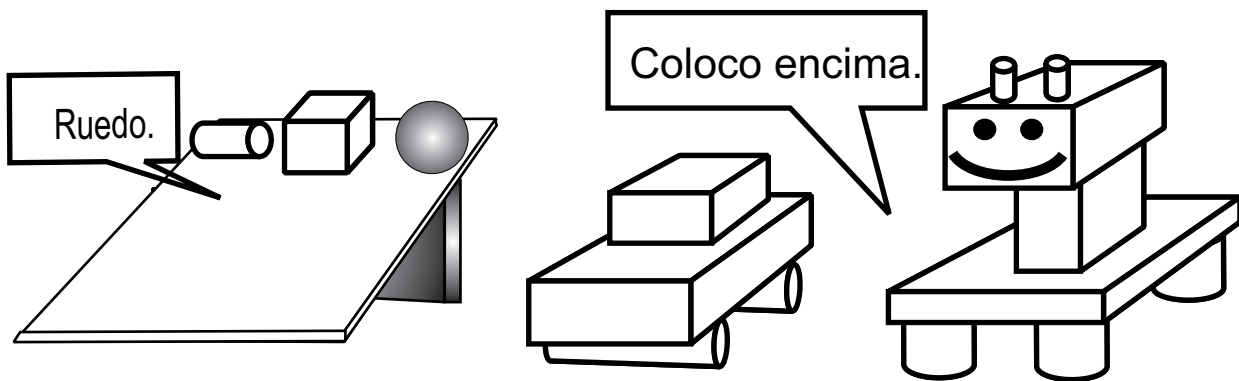

¿Cuál de ellos rueda?

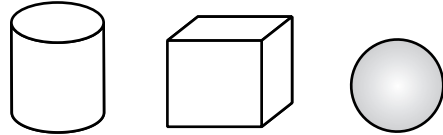

¿Cuál tiene esquina?

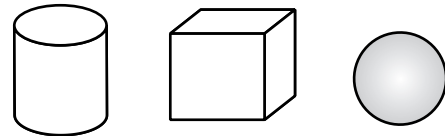

¿A qué objeto se parecen?

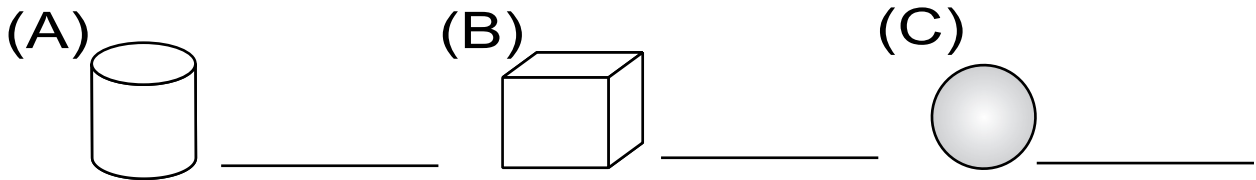

Con una línea uno los objetos parecidos.

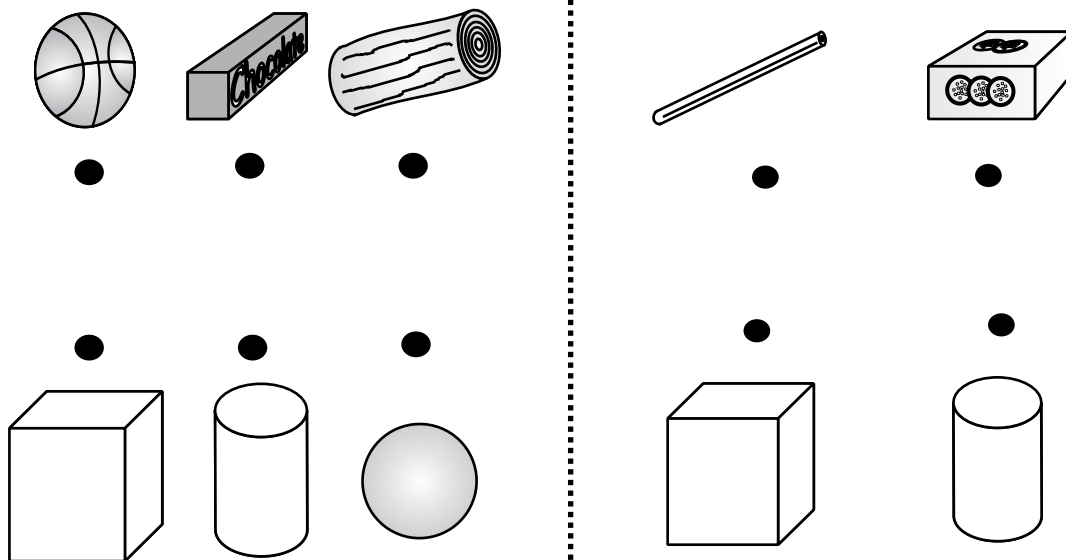



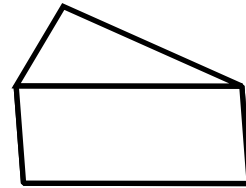
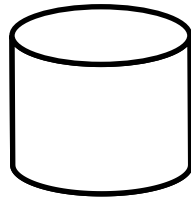
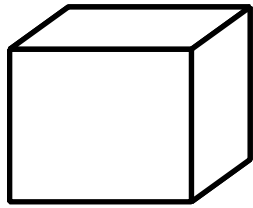

En mi cuaderno copio la base de cada objeto.

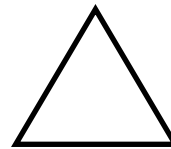
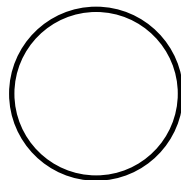

Invento dibujos. Lo hago utilizando cada forma.



Pinto los  de azul, los  de rojo y los  de verde.

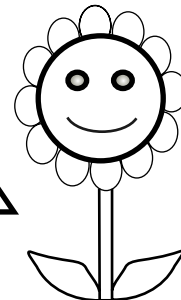
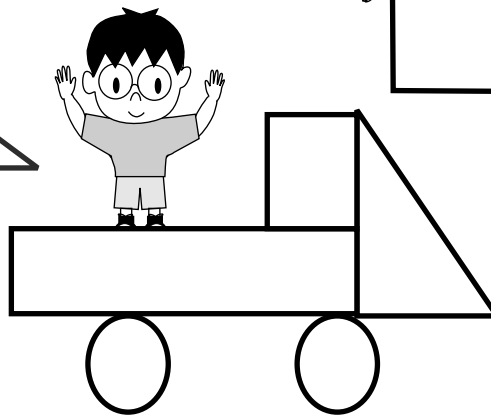
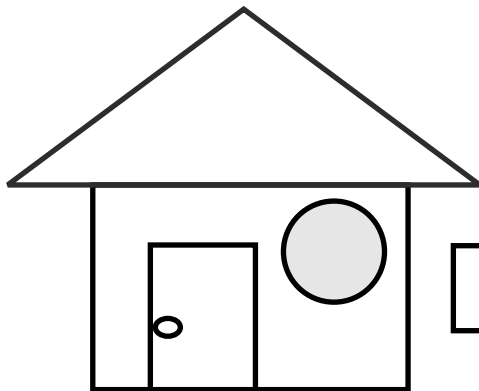
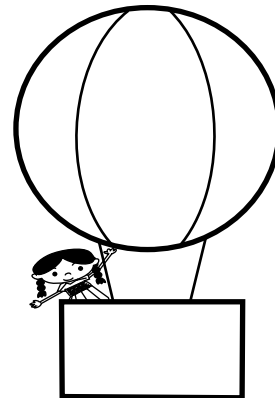
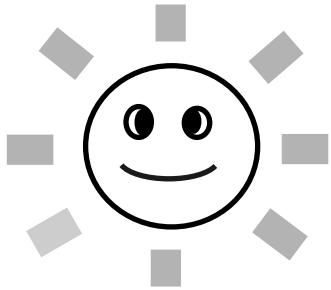



Uno los puntos con línea recta. Sigo el orden de los números.

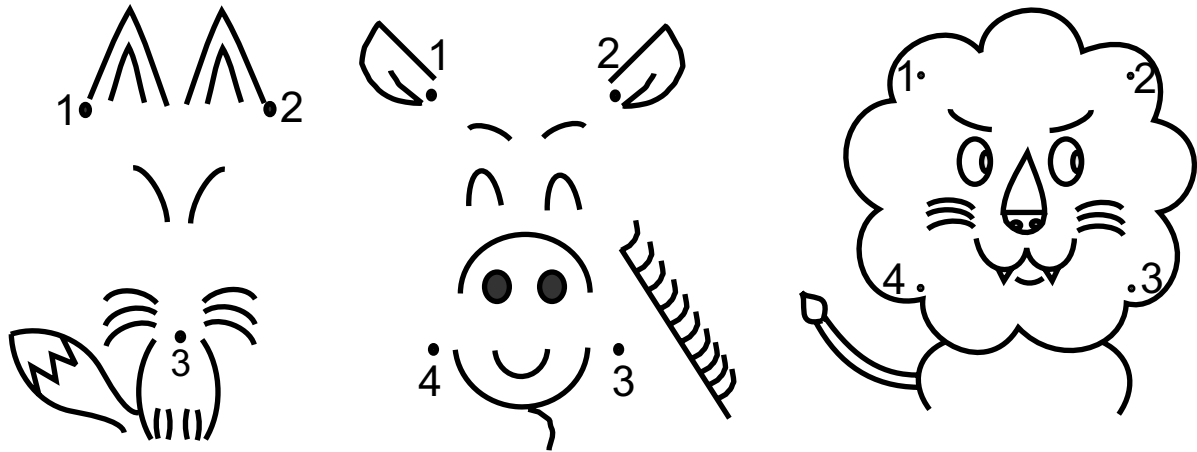

Pinto de rojo los , verde los , azul los  y amarillo los .

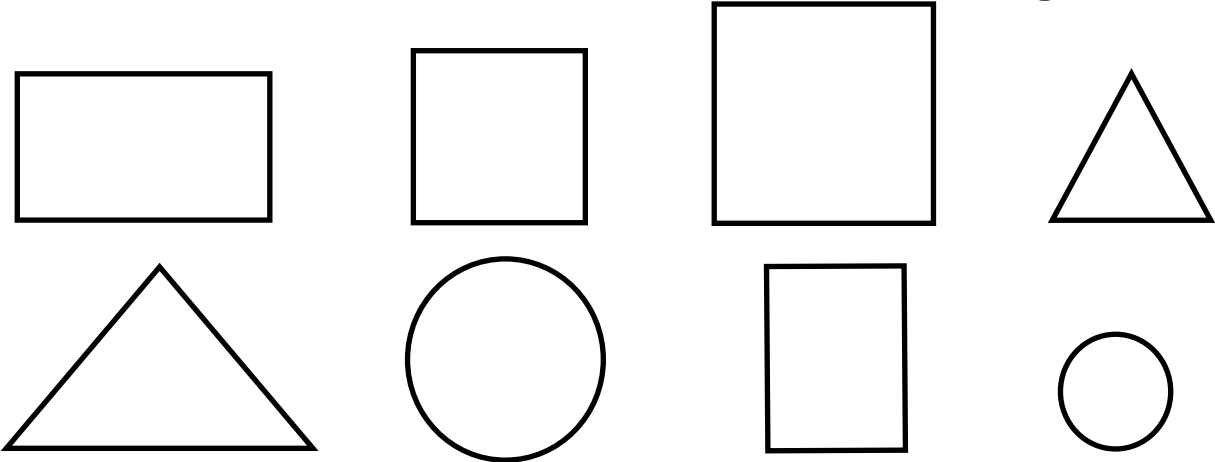

Con una línea uno las figuras parecidas.

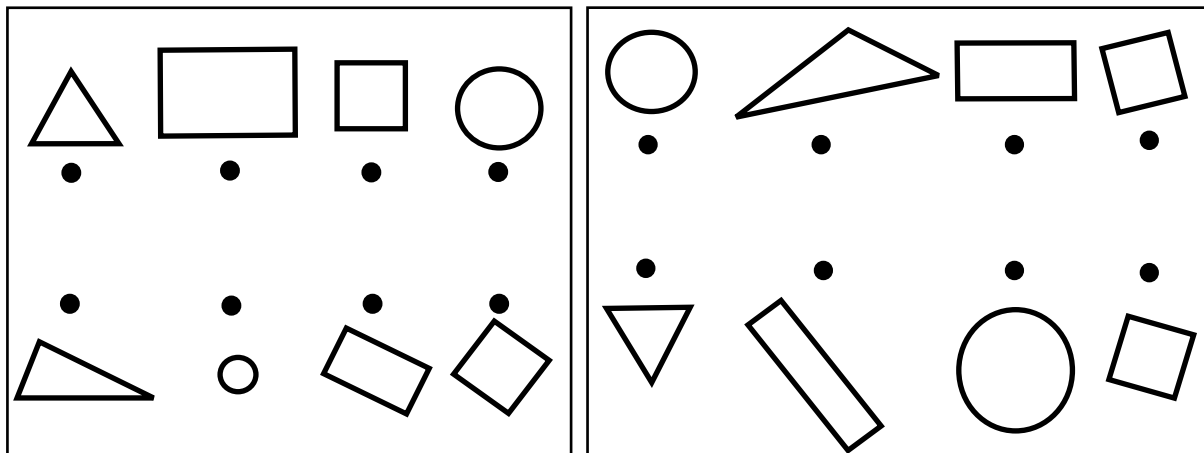



1 Repaso las líneas rectas con crayón verde y las líneas curvas con crayón azul.

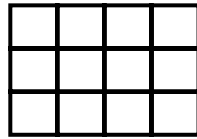
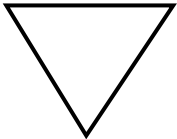
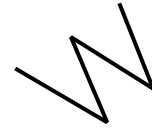

2 Repaso las figuras abiertas con crayón café y las figuras cerradas con crayón rojo.

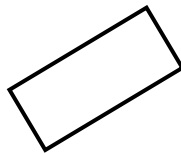
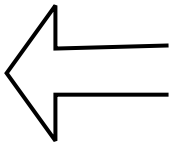
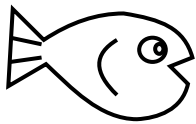

3 Uno los objetos parecidos con una línea.

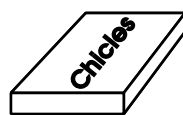
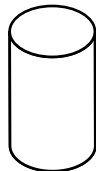
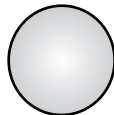
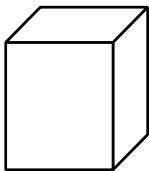

4 Con una línea uno las figuras parecidas.

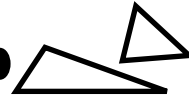
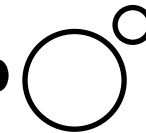



Uno los puntos para encerrar los animales.
Utilizo líneas rectas.

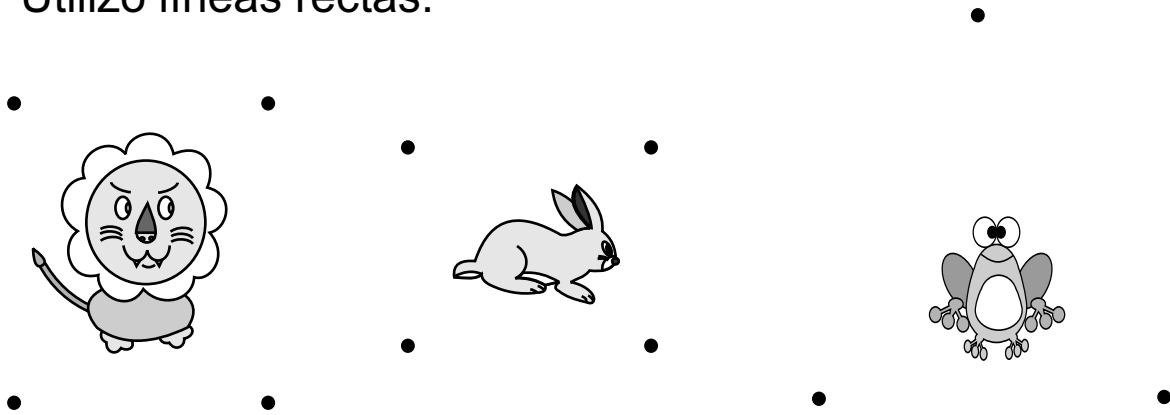

Formo 2 figuras con 7 pajillas
o palitos. Después comparo con
mis compañeros.

- ¿Son parecidos o diferentes?
- ¿En qué se parecen?
- ¿En qué son diferentes?

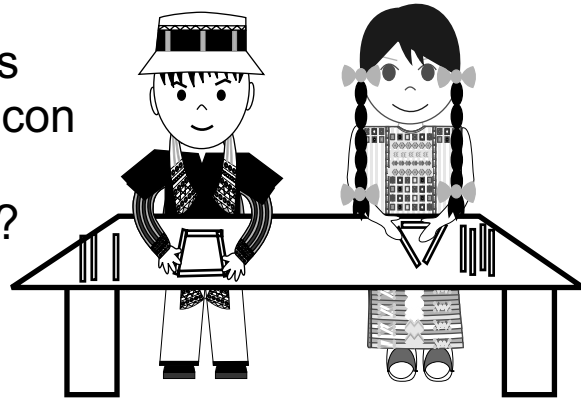

Dibujo uniendo 3 ó 4 puntos.

