

Big and Small Shapes

An Interactive Emergent Reader

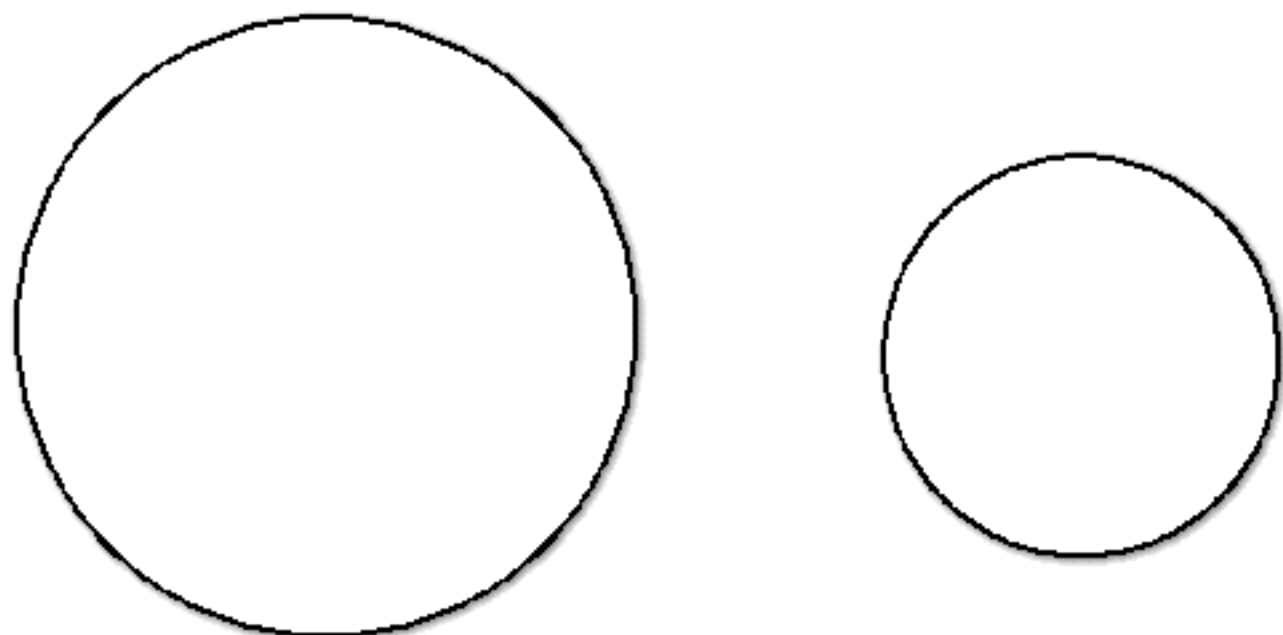

www.childcareland.com

This is a big rectangle.

www.childcareland.com

This is a small rectangle.

This is a big circle.

This is a small circle.

This is a big square.

This is small square.

This is a big triangle.

This is a small triangle.

This is a big oval.

This is a small oval.

This is a big star.

This is a small star.

The End!!

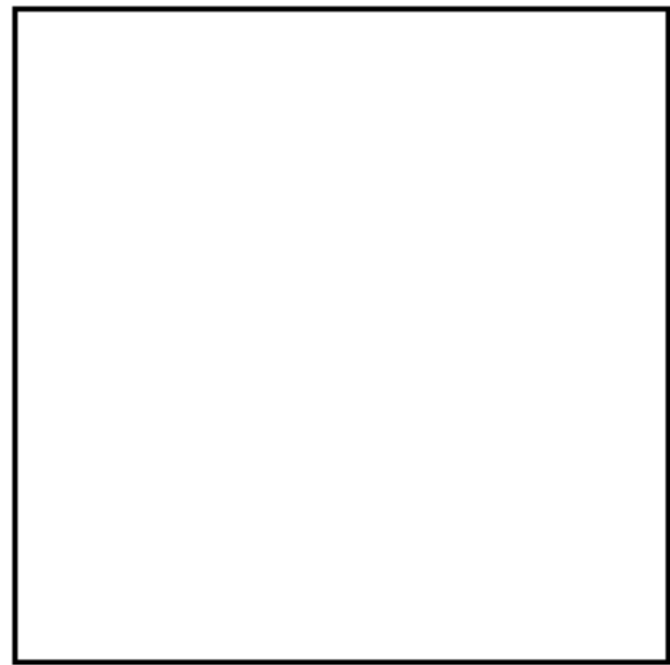
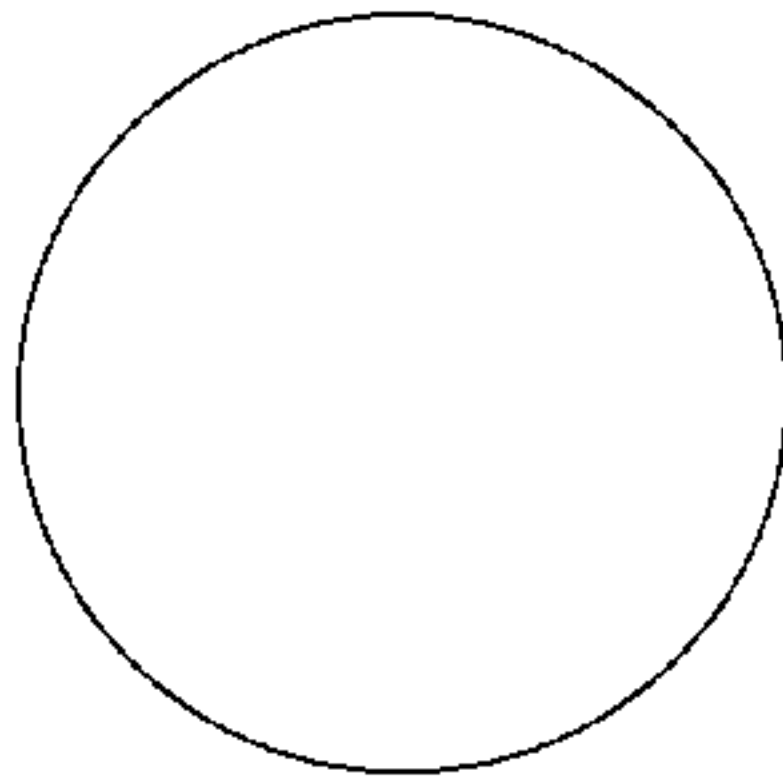
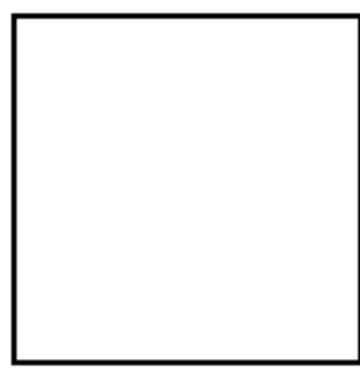
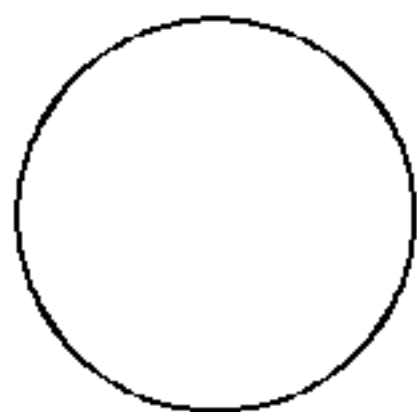

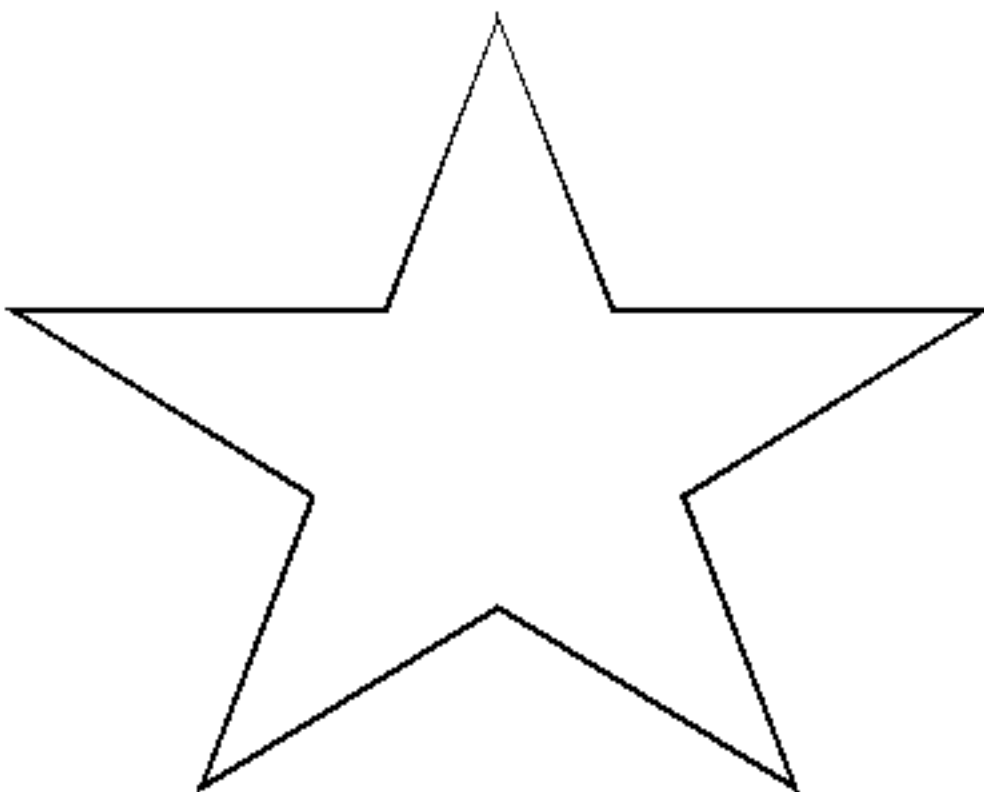
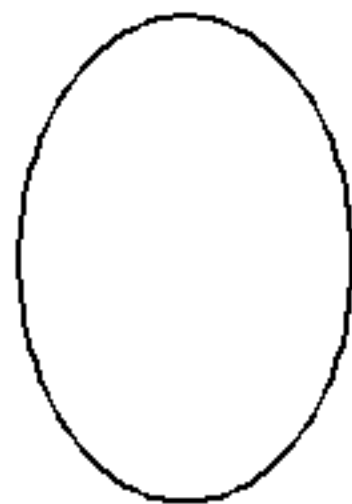
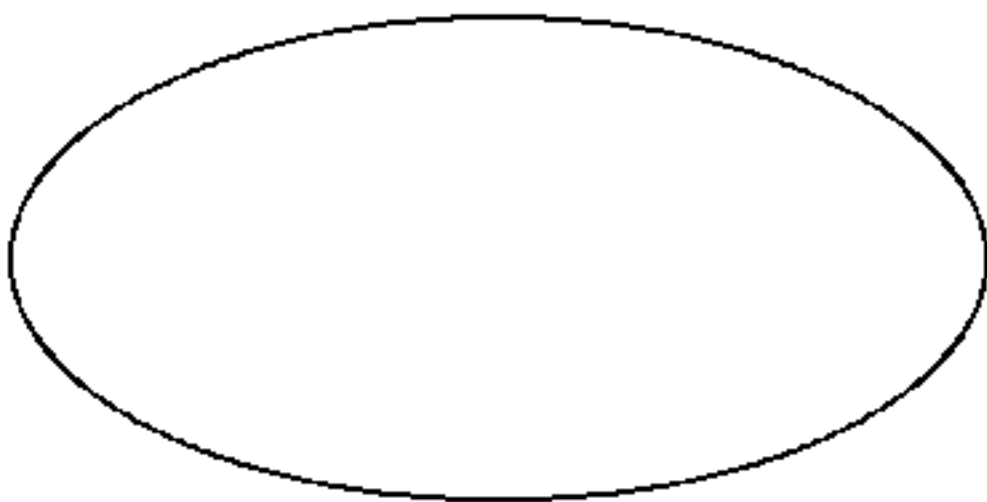
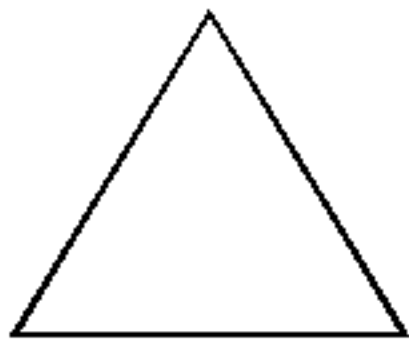
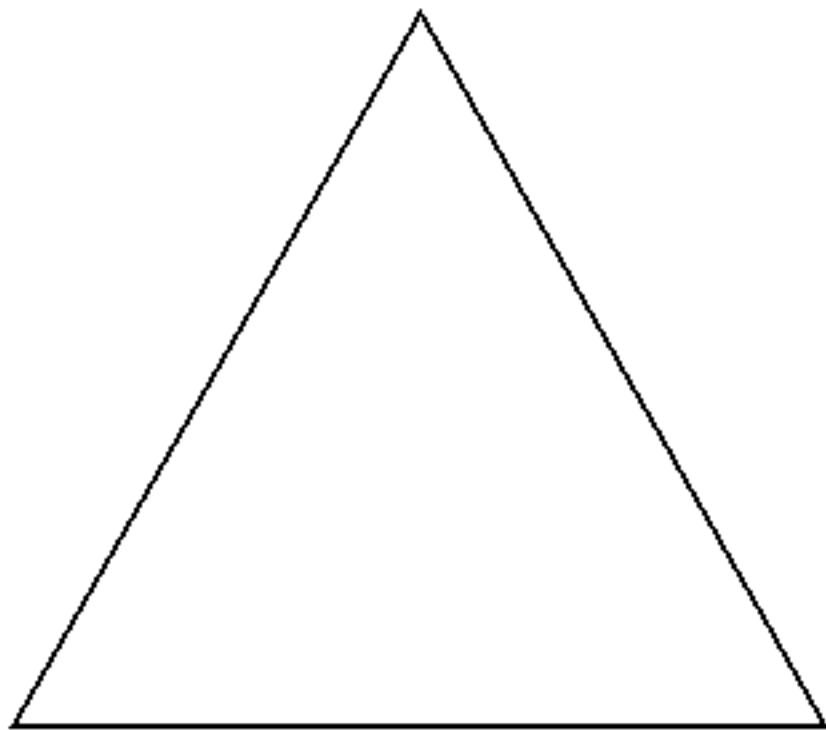

Big and Small Shapes Instructions.

Print book patterns ... cut and assemble. Have children cut the shapes out and glue on the correct page. Adults can cut out the shapes for younger children.

Summer Learning Friends Shape Match Book

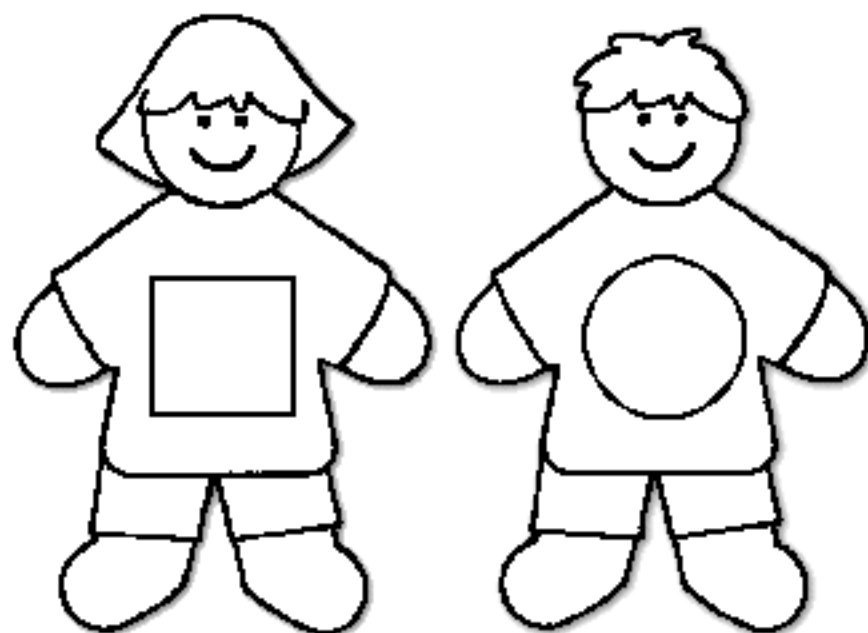

www.childcareland.com

I see a learning friend with a rectangle.

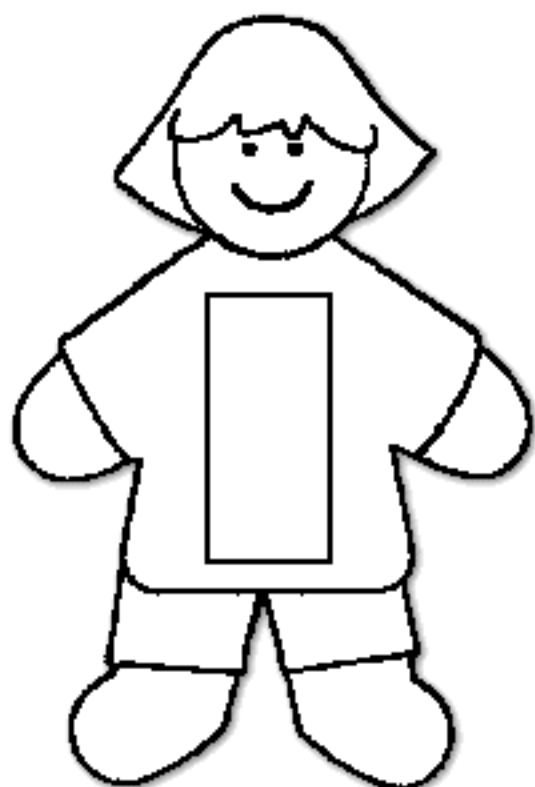

www.childcareland.com

I see a learning friend with a square.

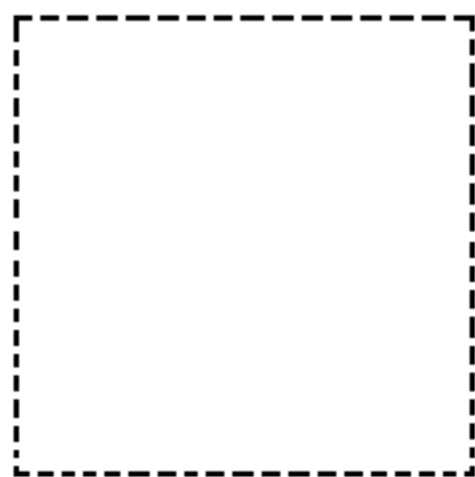
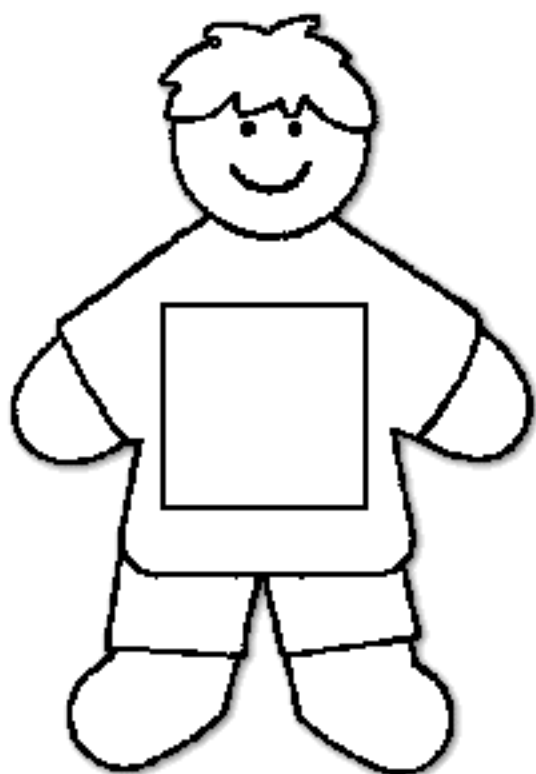

www.childcareland.com

I see a learning friend with an oval.

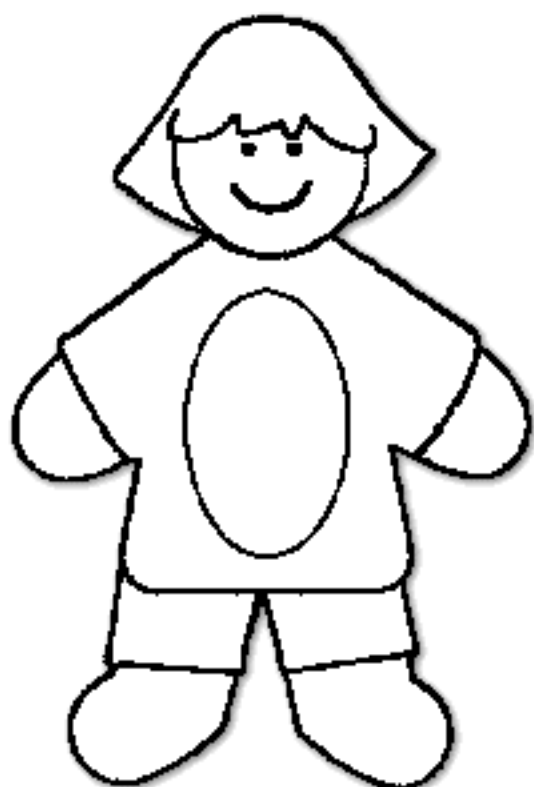

www.childcareland.com

I see a learning friend with a circle.

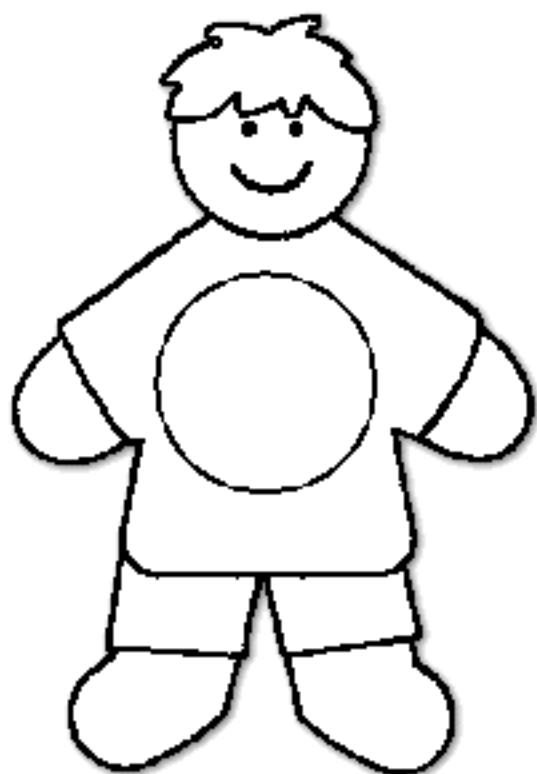

www.childcareland.com

I see a learning friend with a triangle.

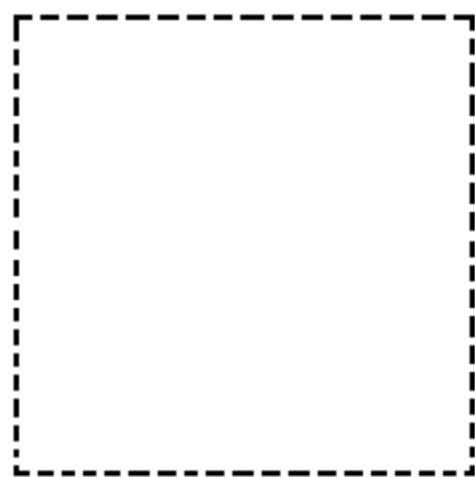
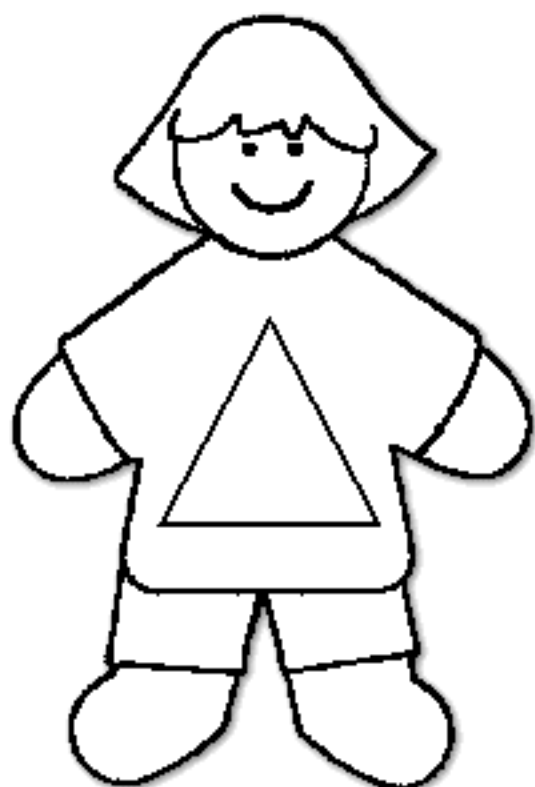

www.childcareland.com

I see a learning friend with a star.

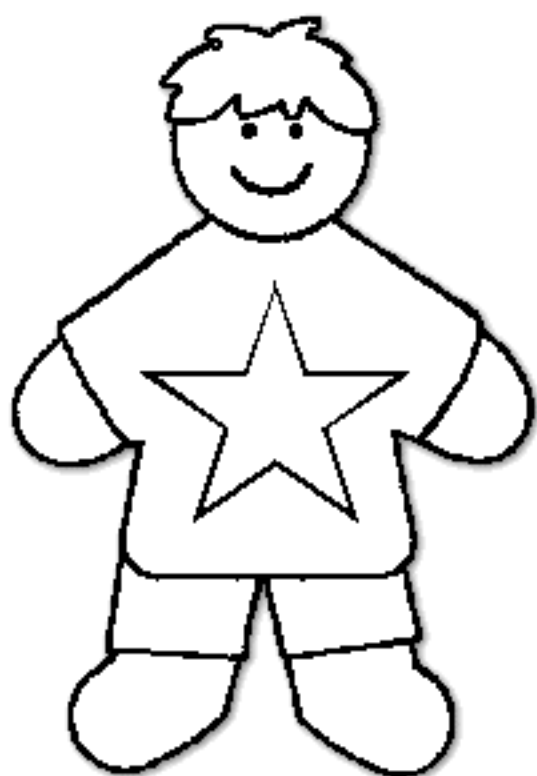

www.childcareland.com

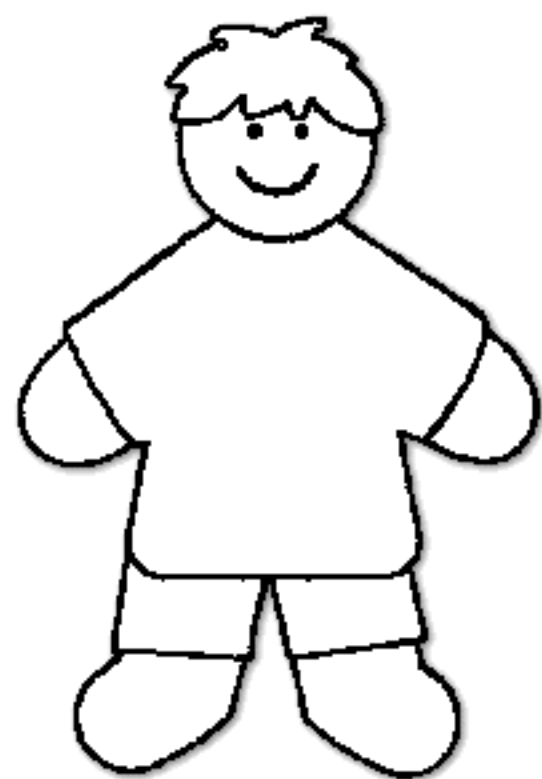

The End!

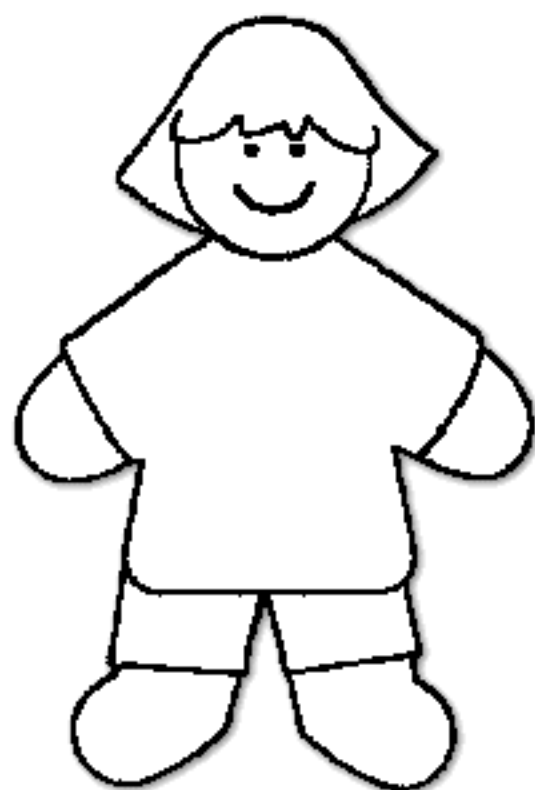

www.childcareland.com

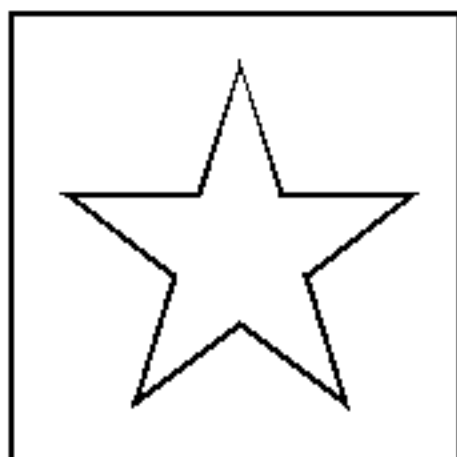
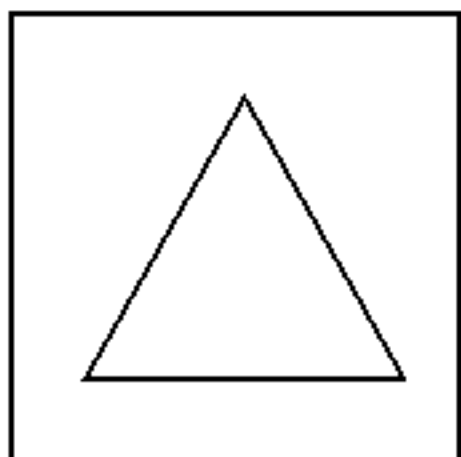
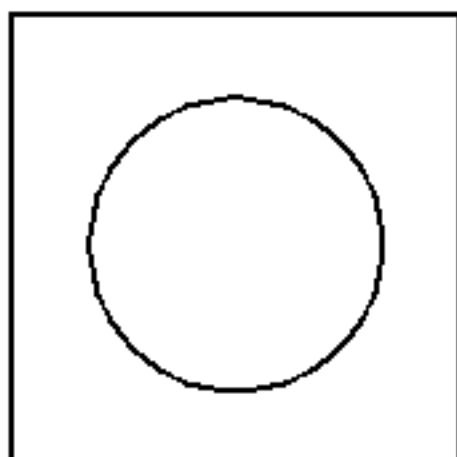
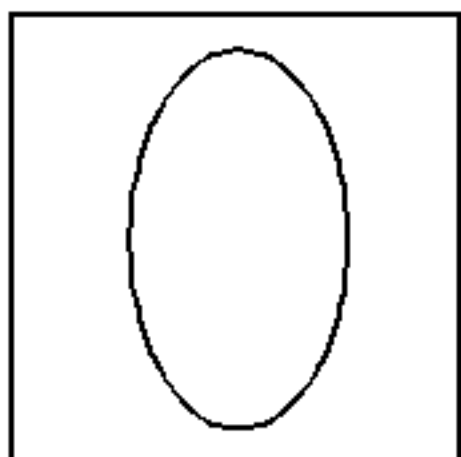
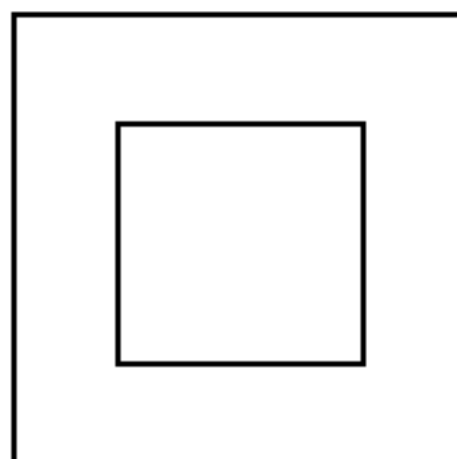
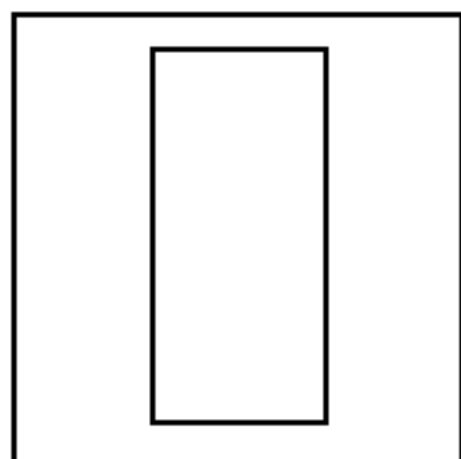

Instructions: Print book and assemble. Cut out shape squares and glue on the correct blank square in the learning friends shape book.

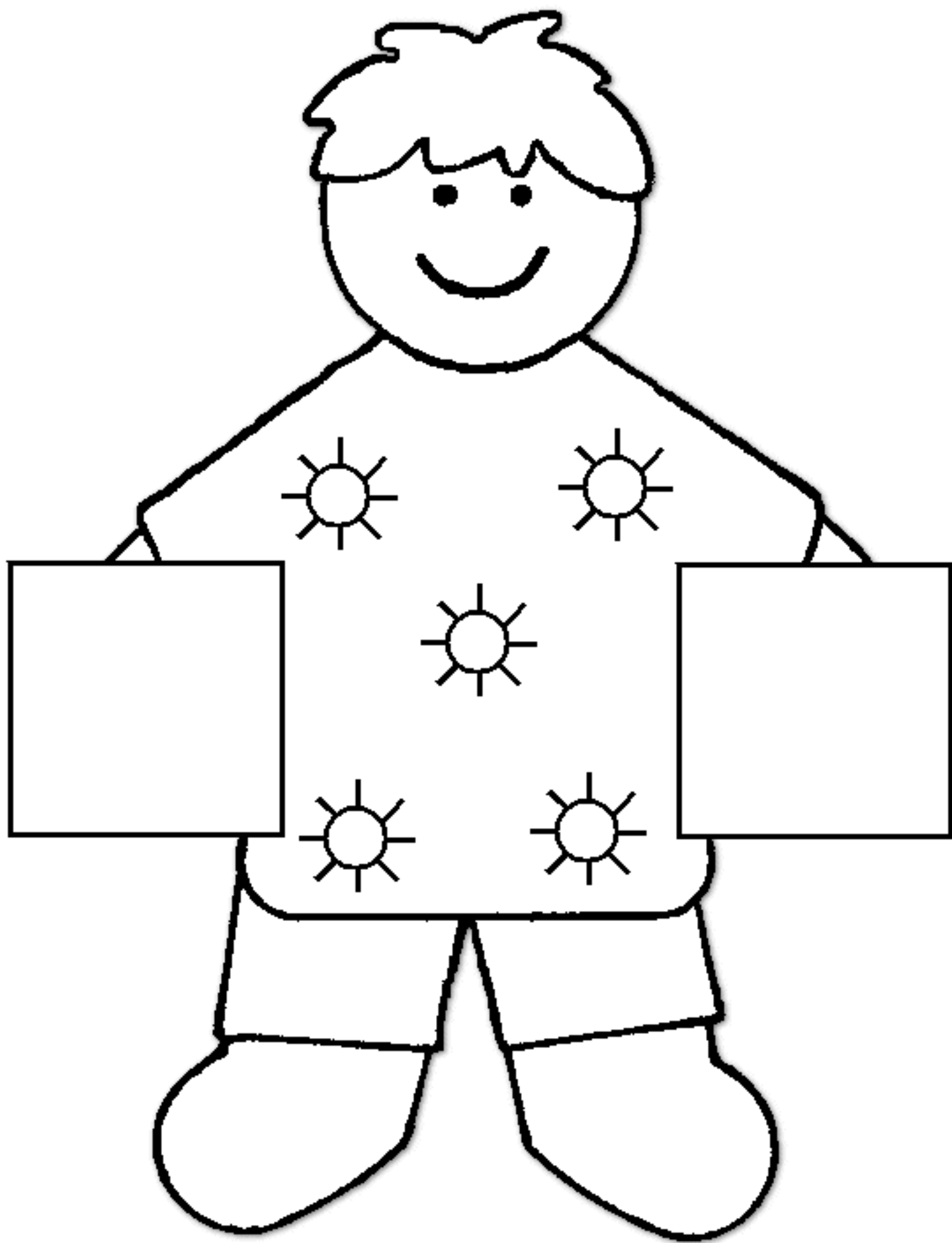

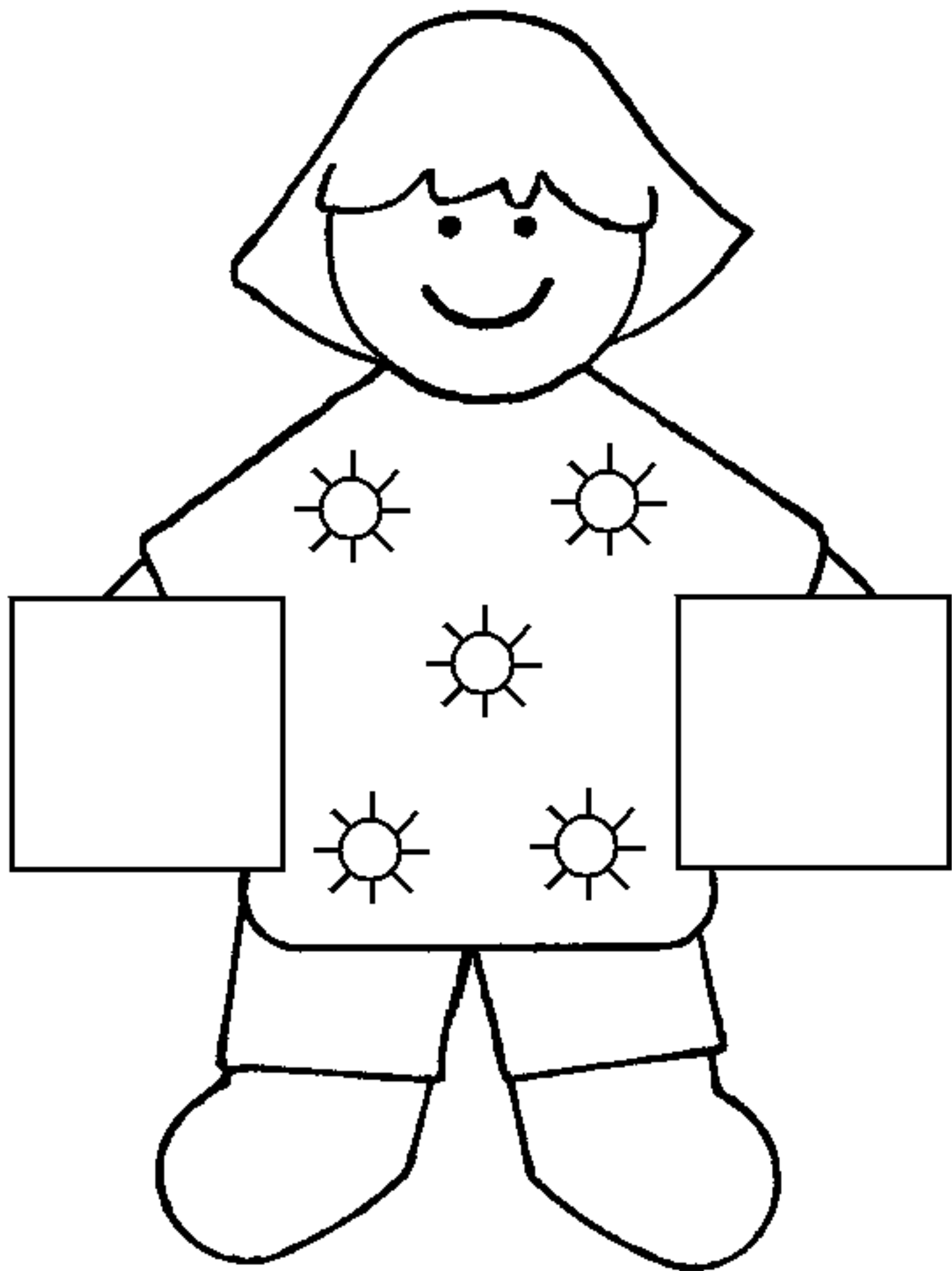

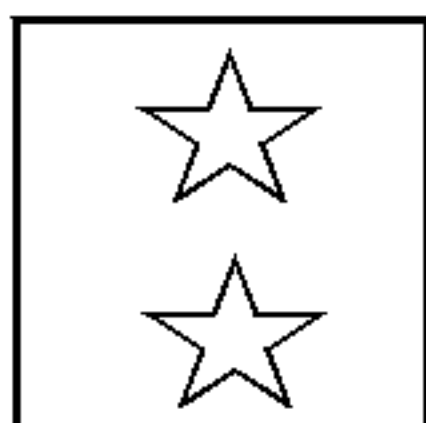
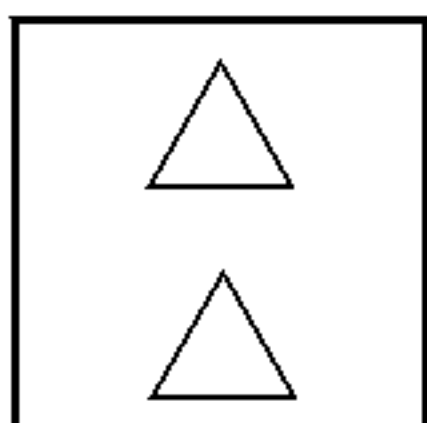
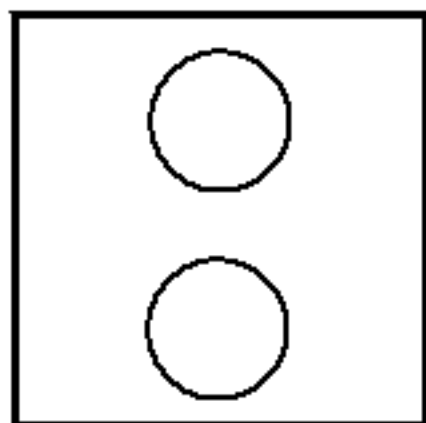
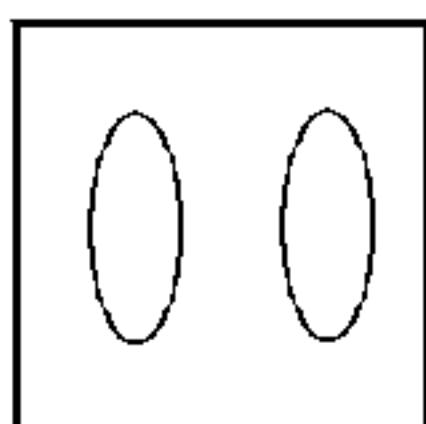
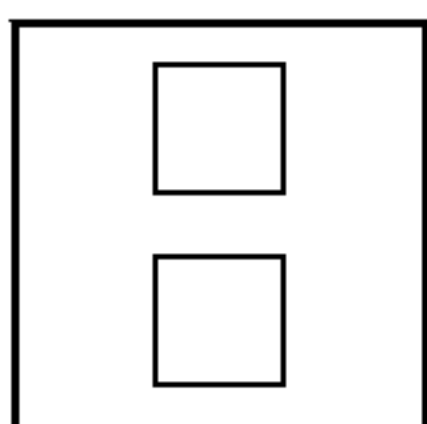
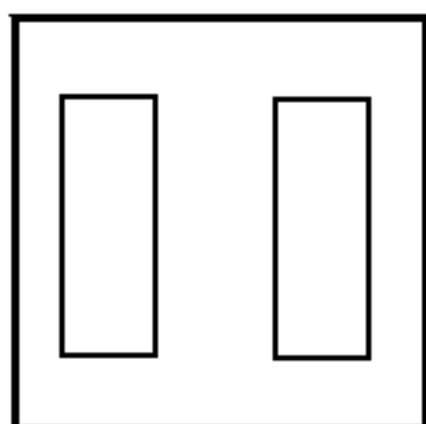
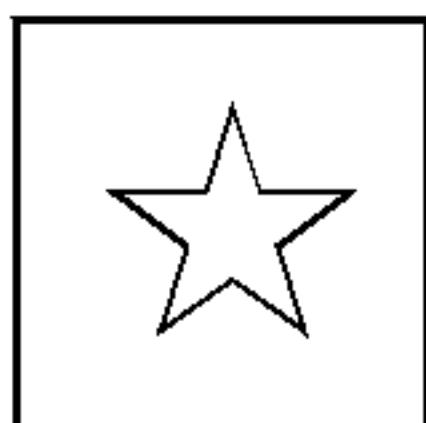
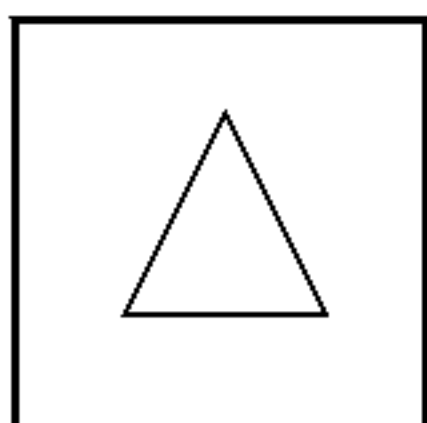
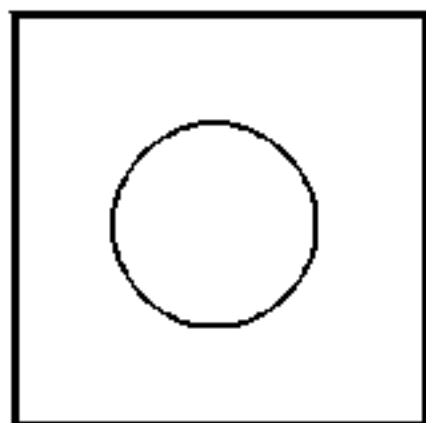
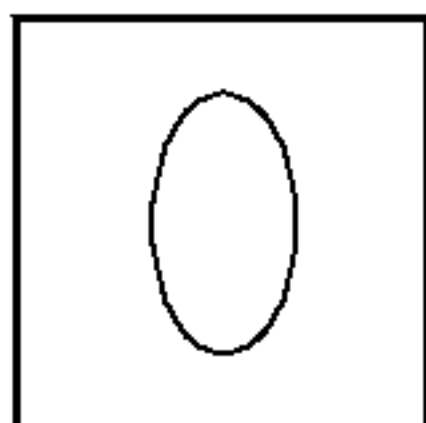
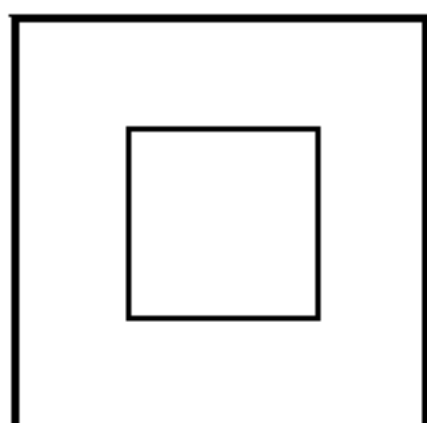
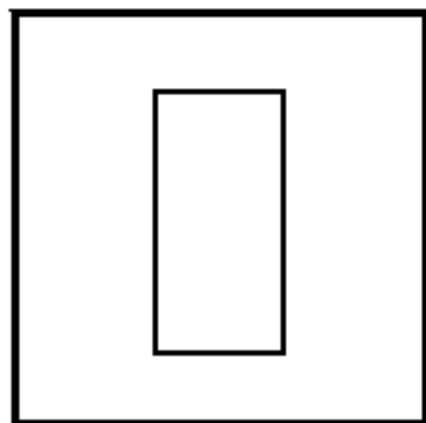

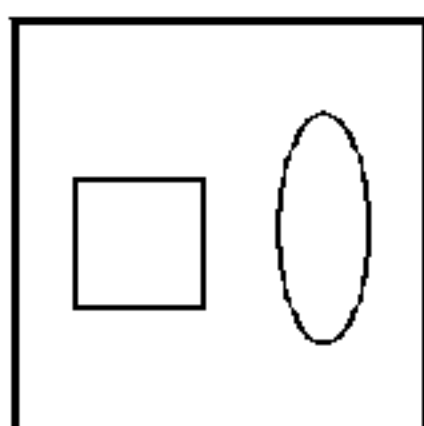
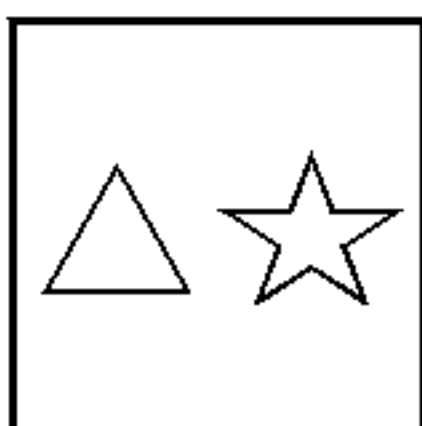
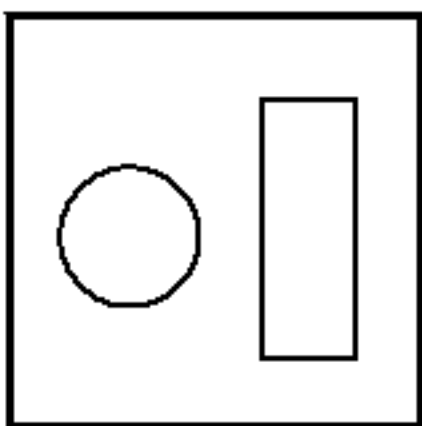
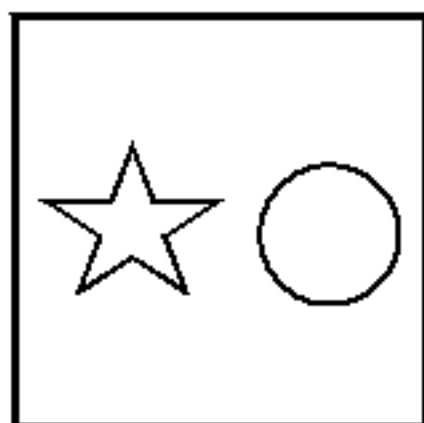
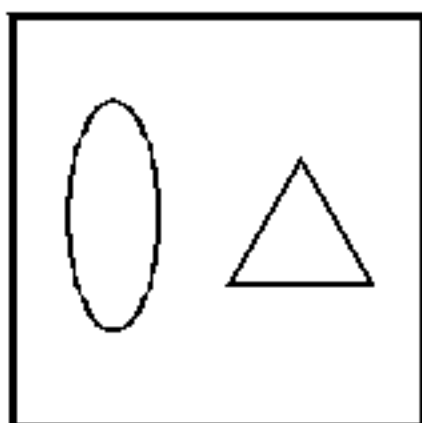
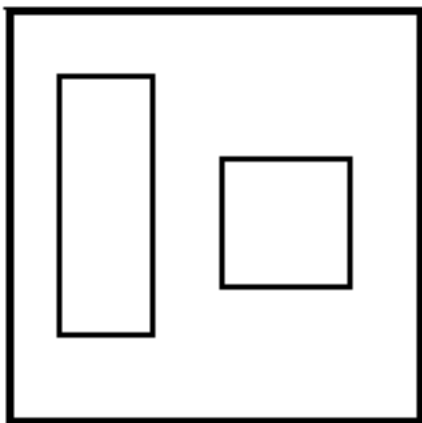

Summer Learning Friends Shape Match

Instructions: Print on cardstock (make two copies of the shape squares). Laminate learning friends mat and cut out shape squares and laminate. Place one shape square on the left blank square on the learning friends mat ... put the matching shape square on on the right blank square.

Watermelon Shape Match Book



www.childcareland.com

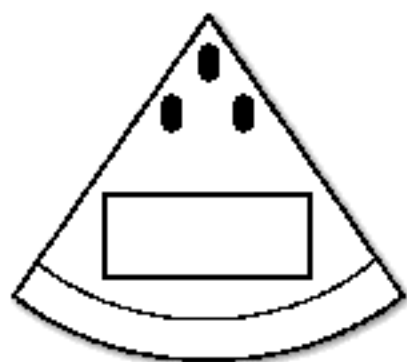

www.childcareland.com

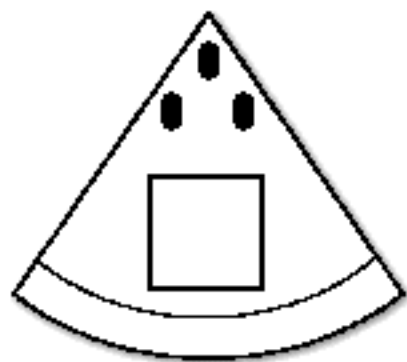

www.childcareland.com



www.childcareland.com



www.childcareland.com

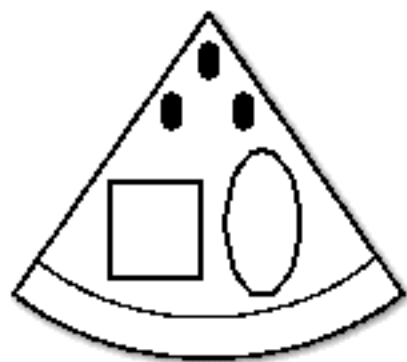

www.childcareland.com



www.childcareland.com



The End!!



www.childcareland.com

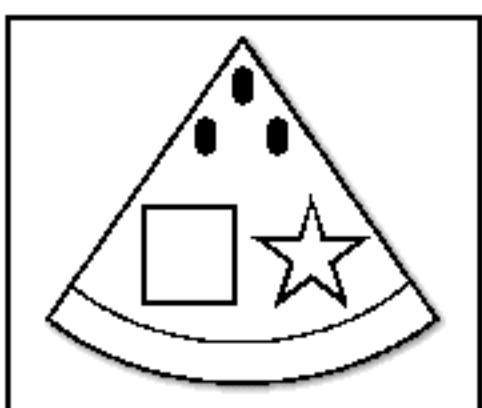
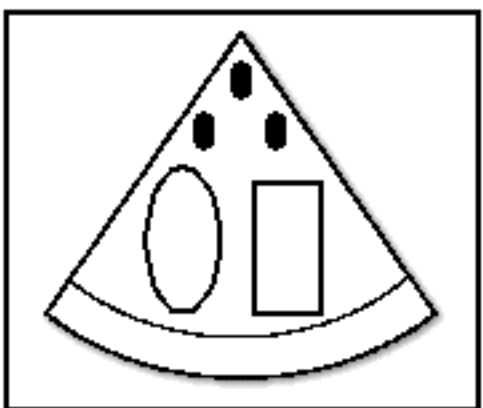
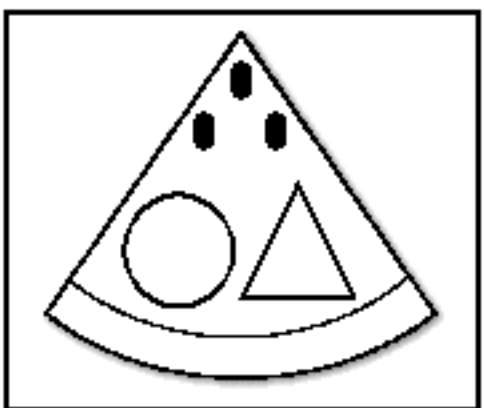
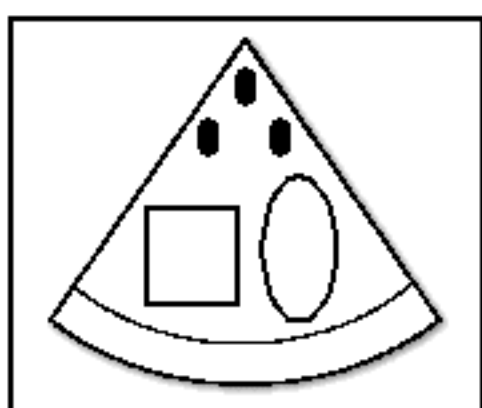
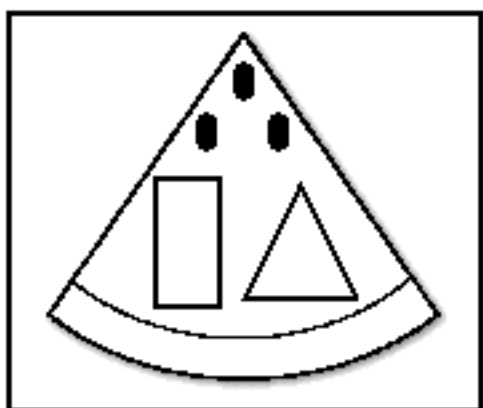
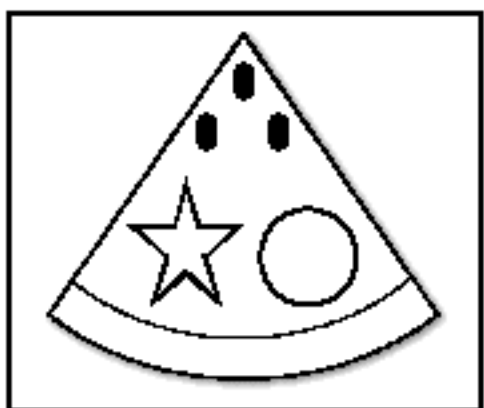
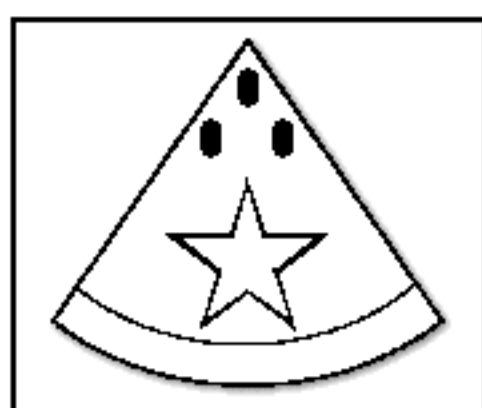
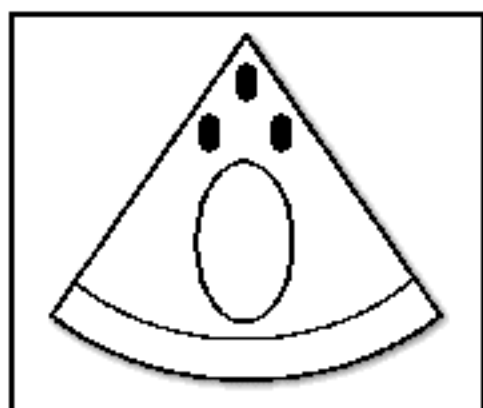
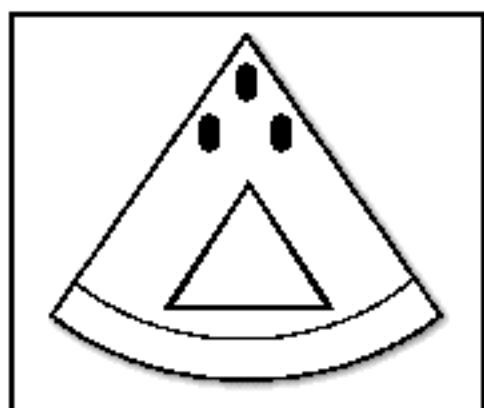
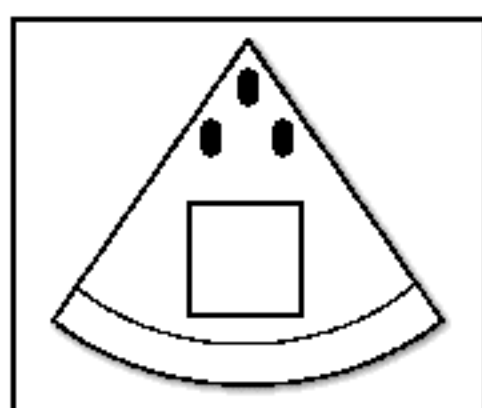
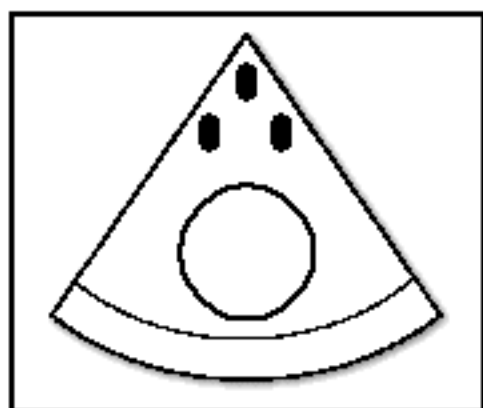
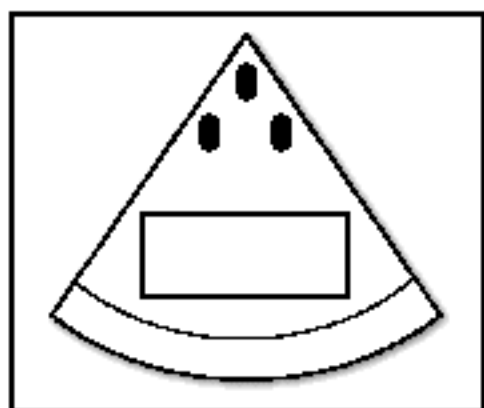

Watermelon Shape Match Book

Instructions: Print book cut and assemble. Print watermelon shape squares. Children cut squares out and glue next to the watermelon with the same shape. For younger children the squares can be pre-cut and they would then glue them on in the correct place in the book.

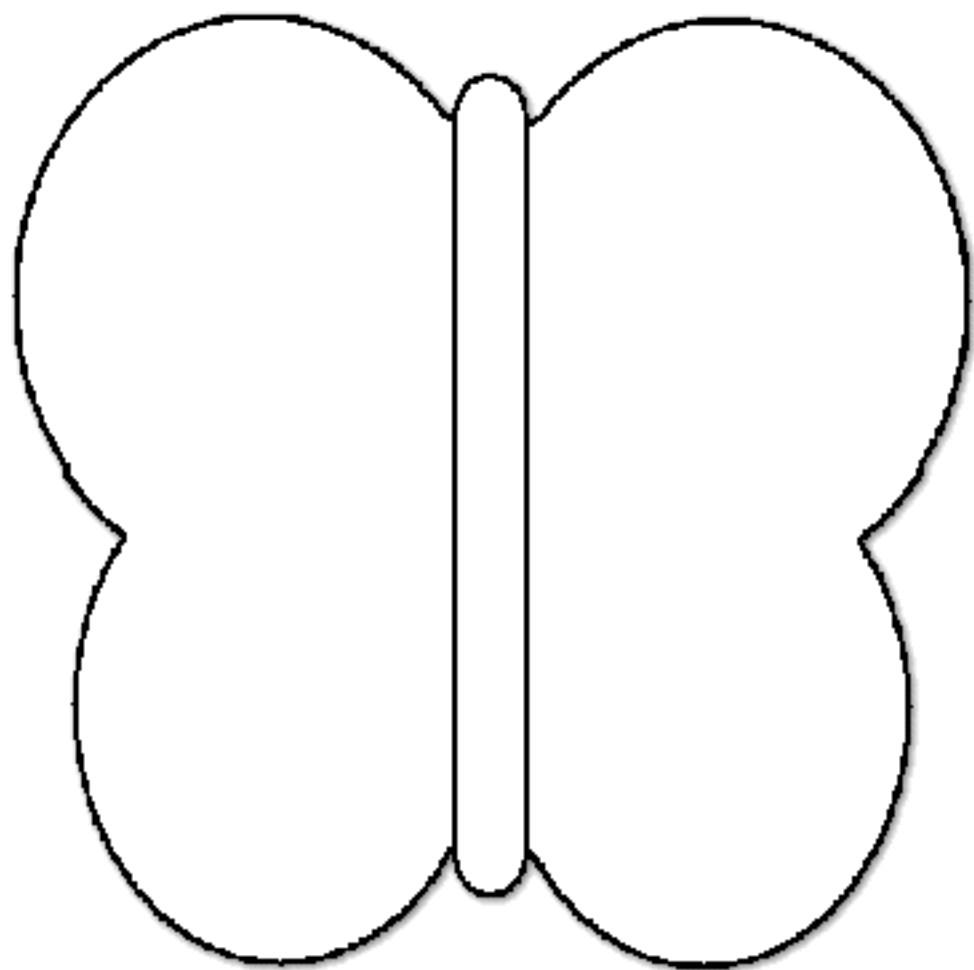
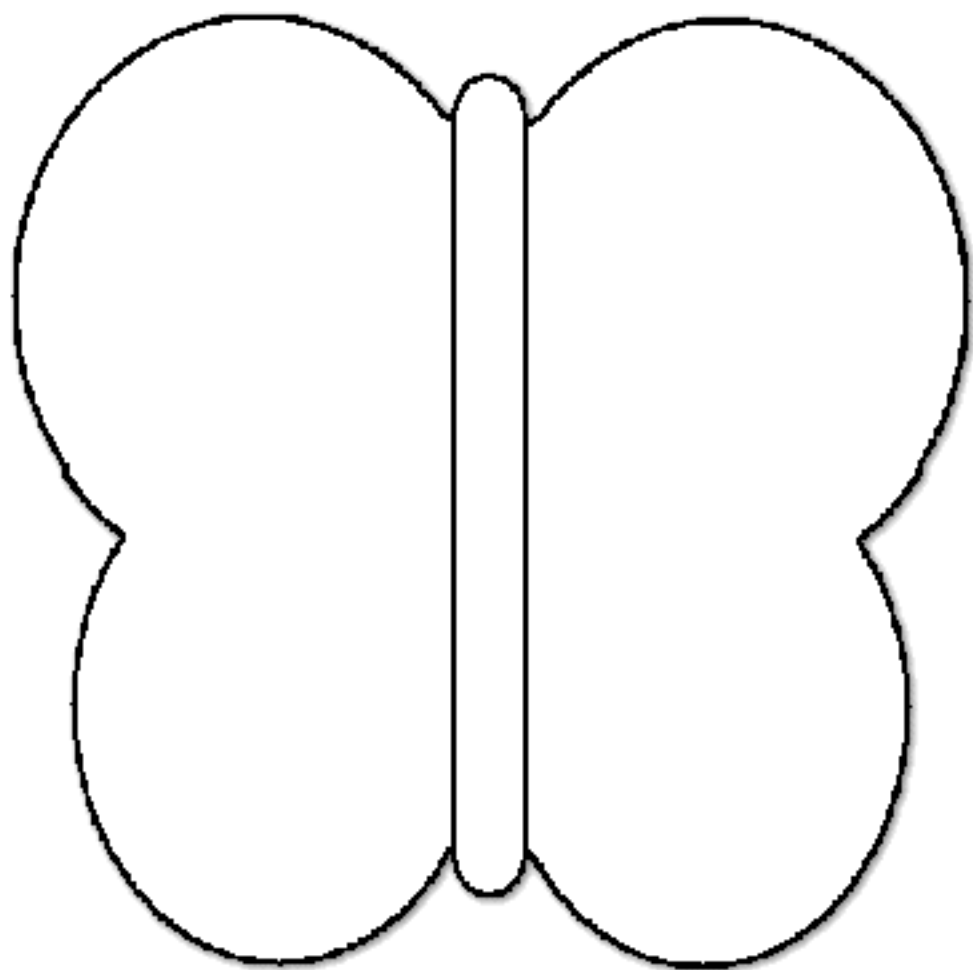

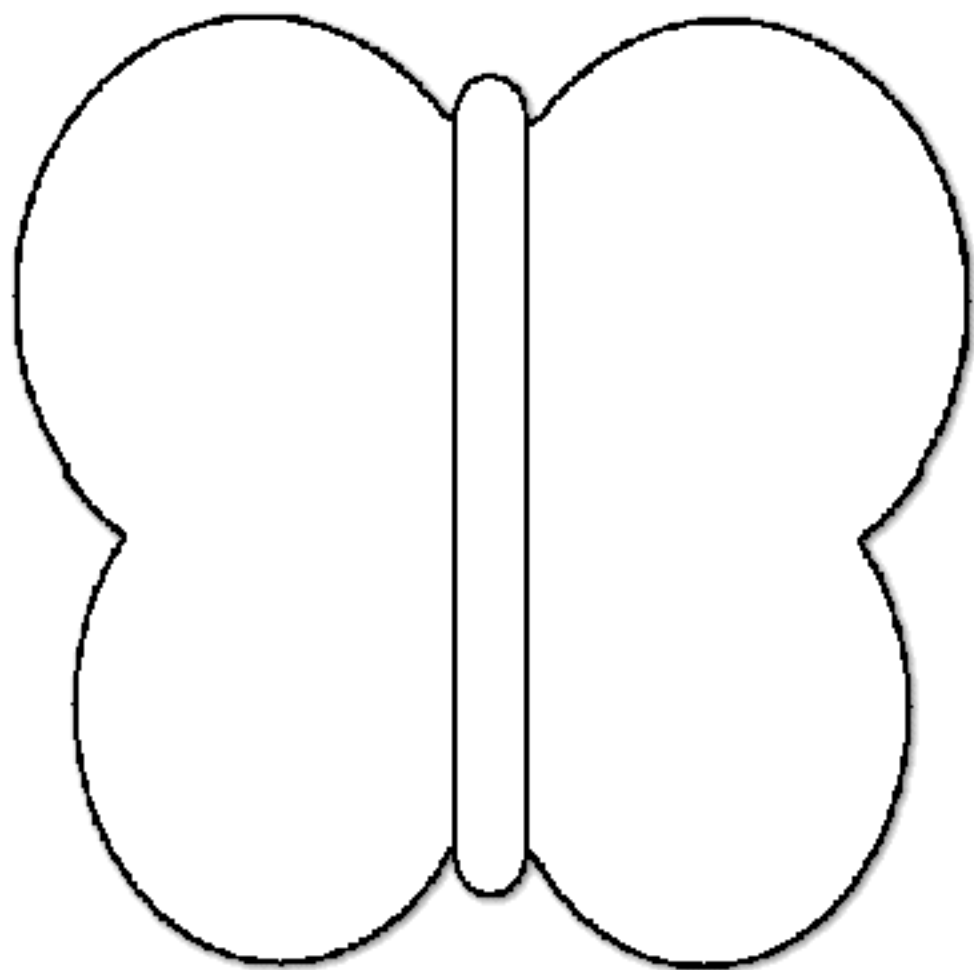
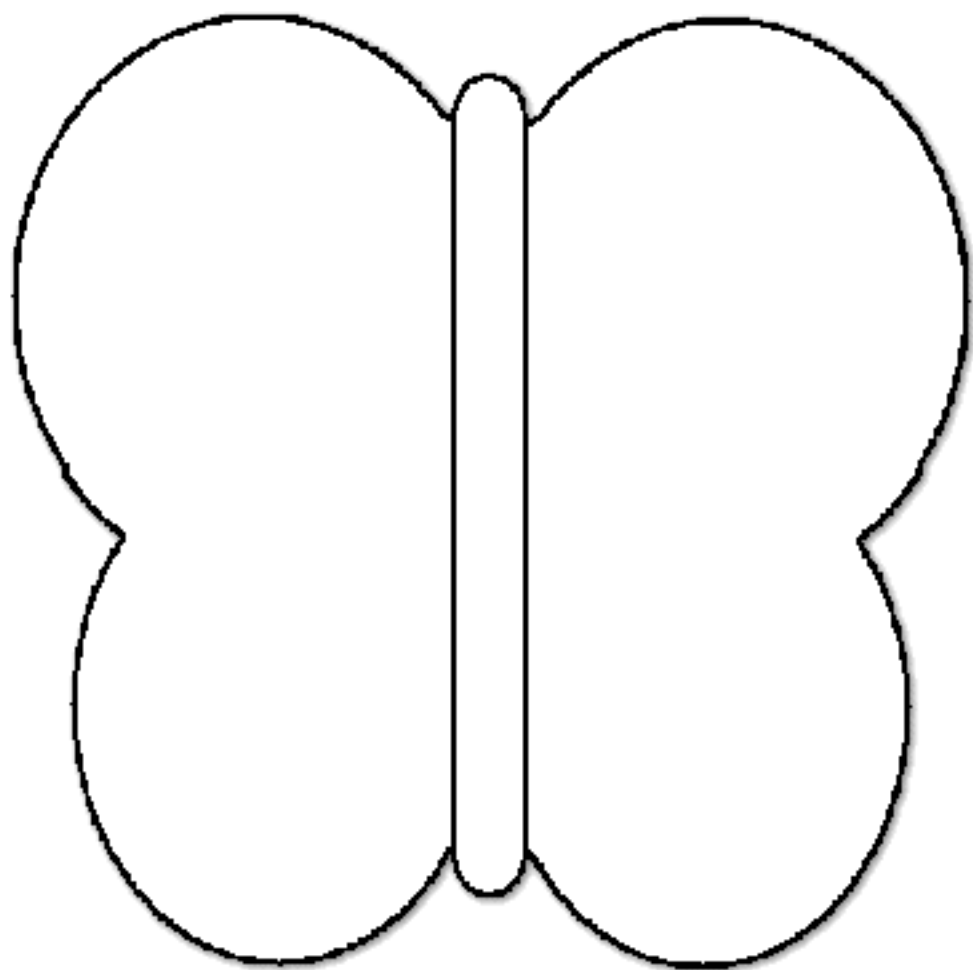

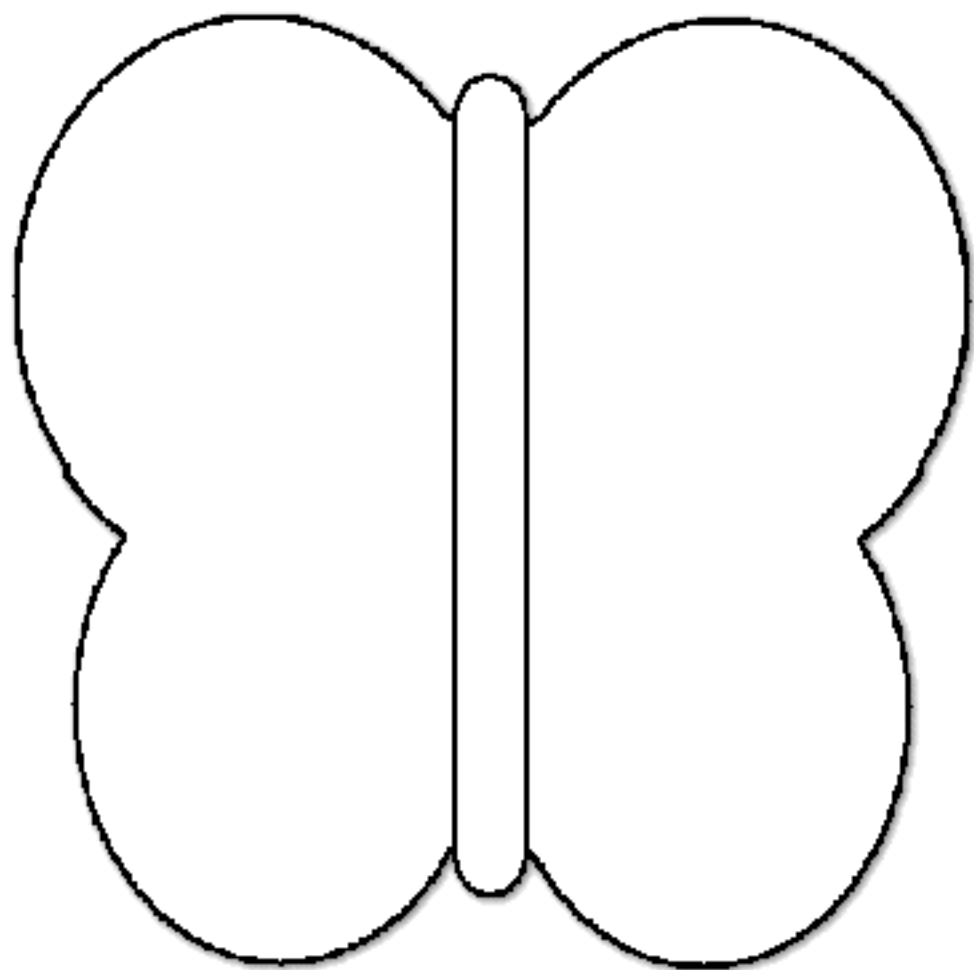
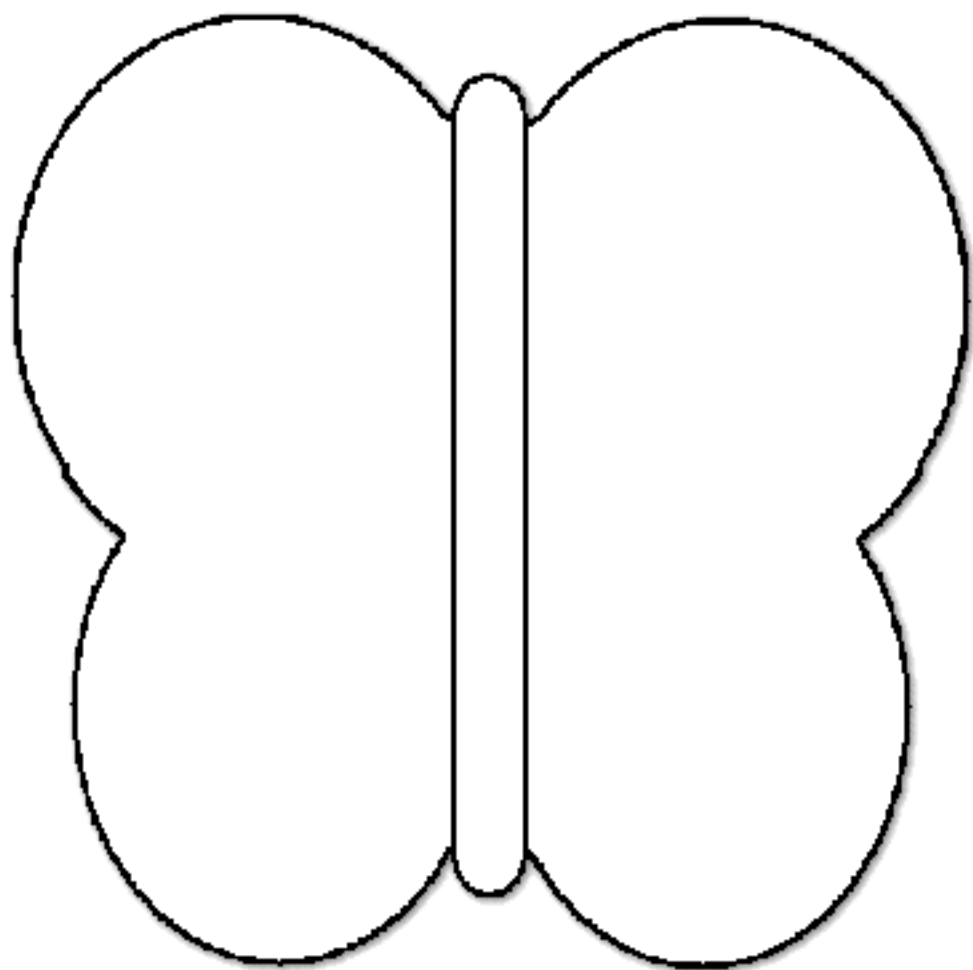

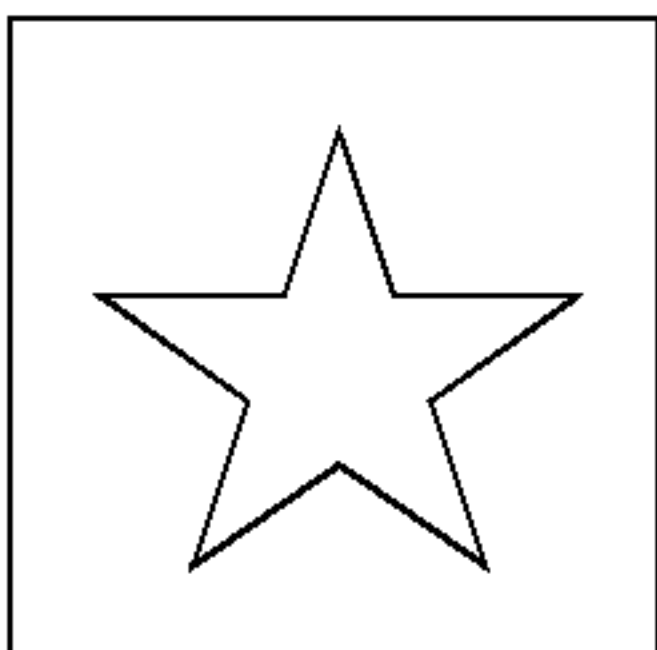
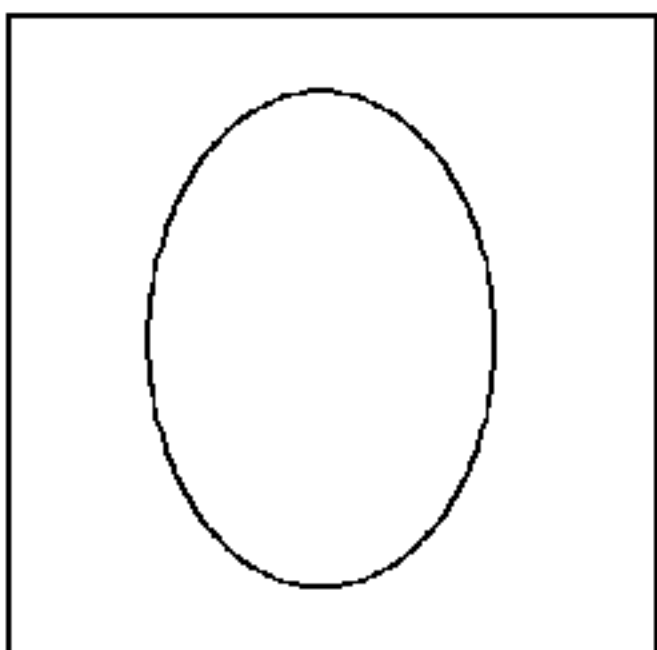
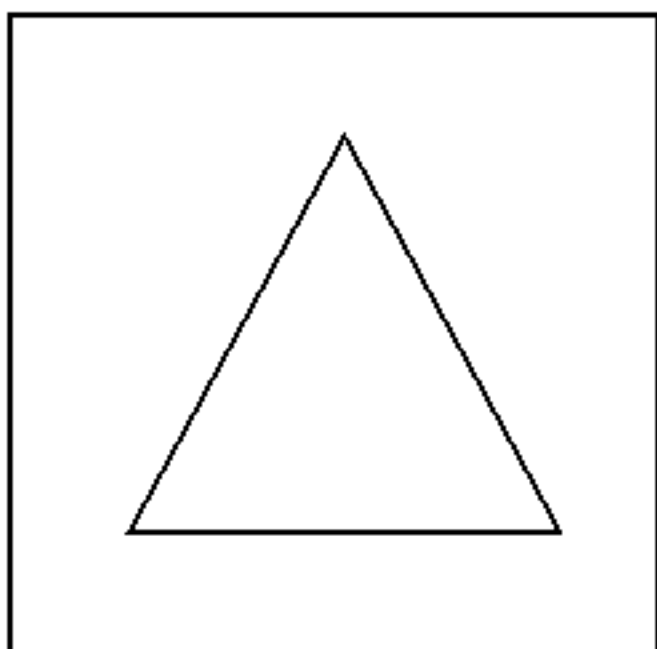
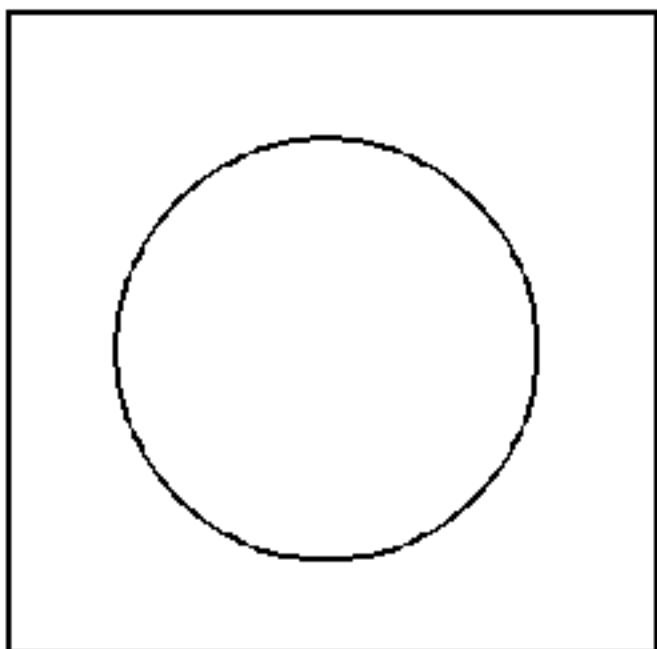
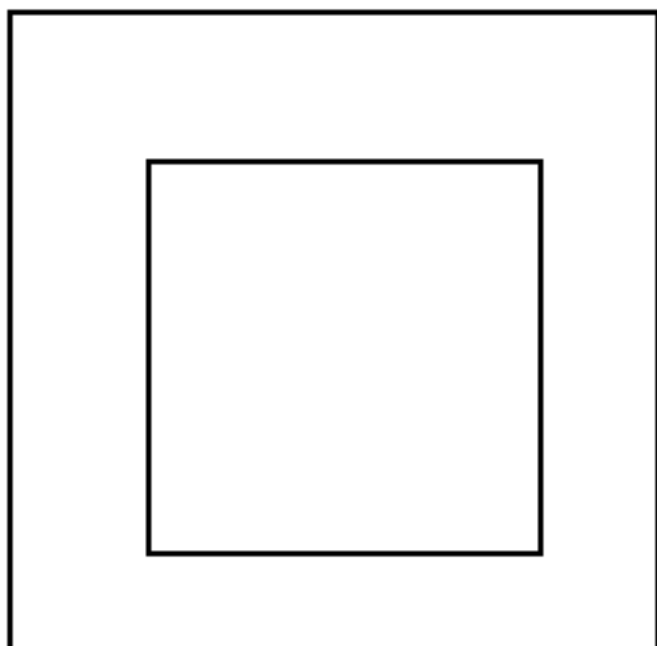
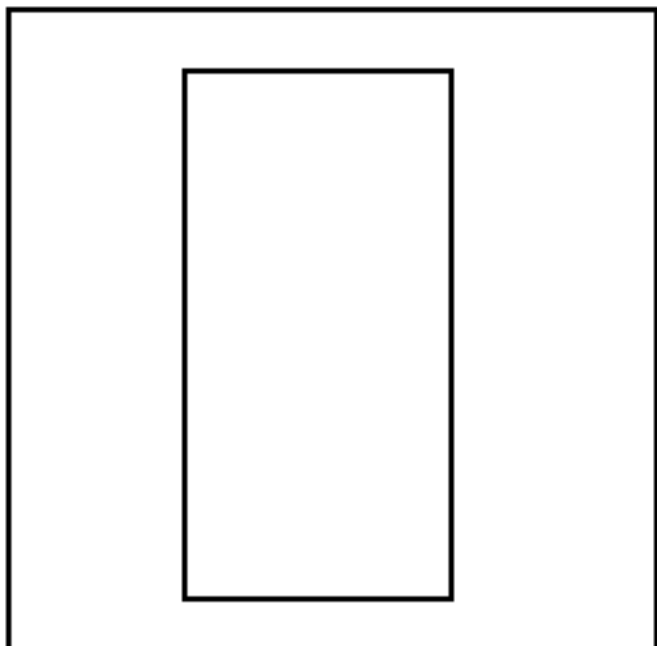

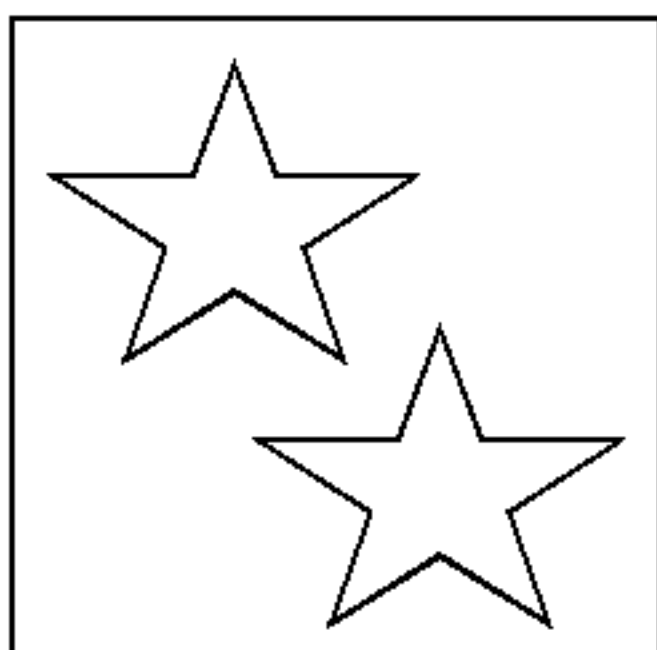
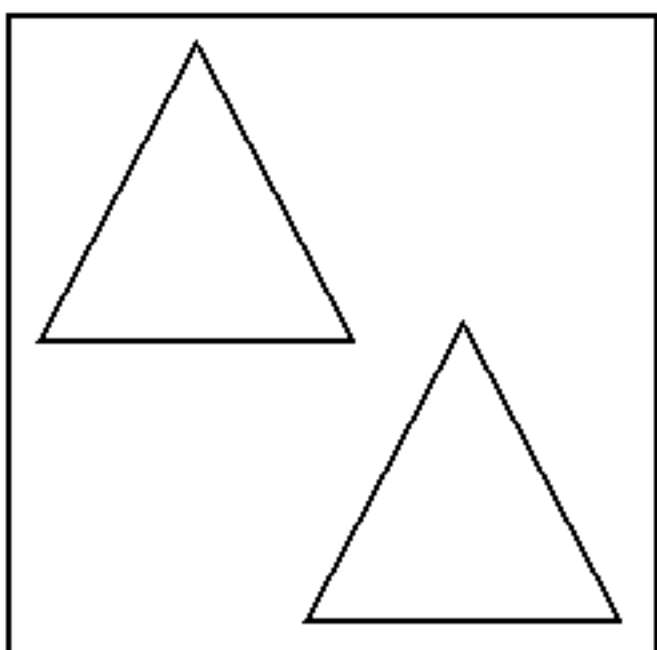
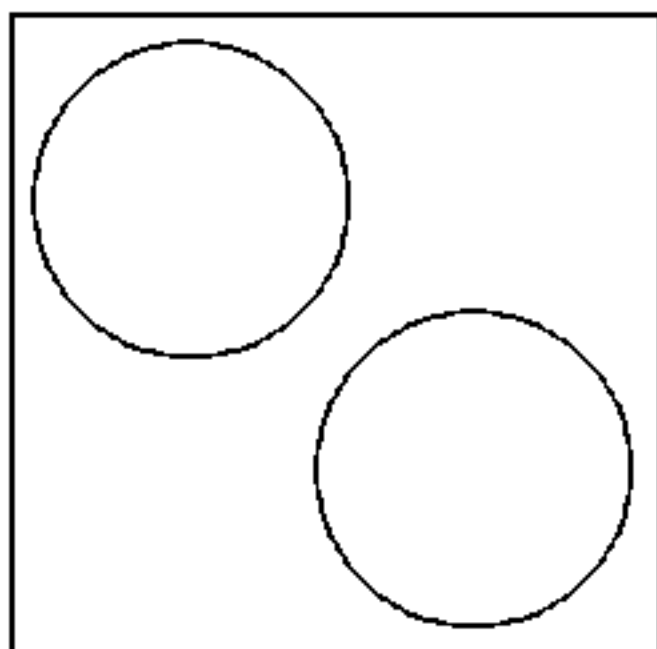
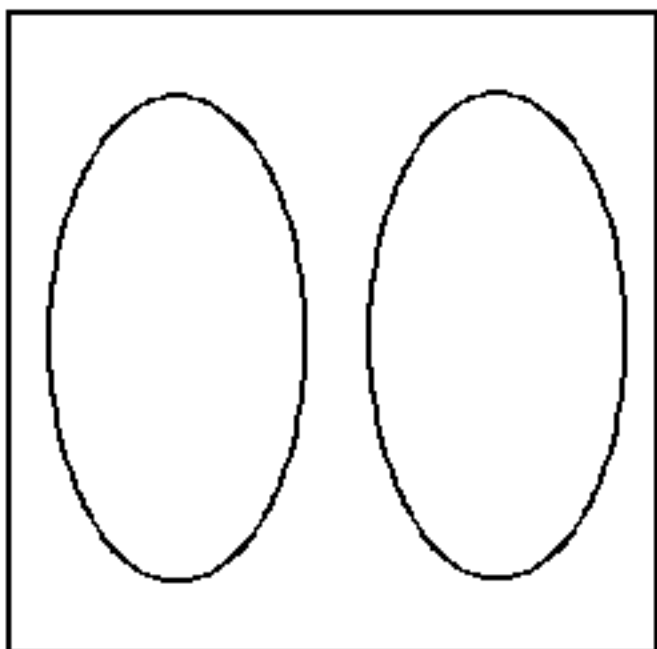
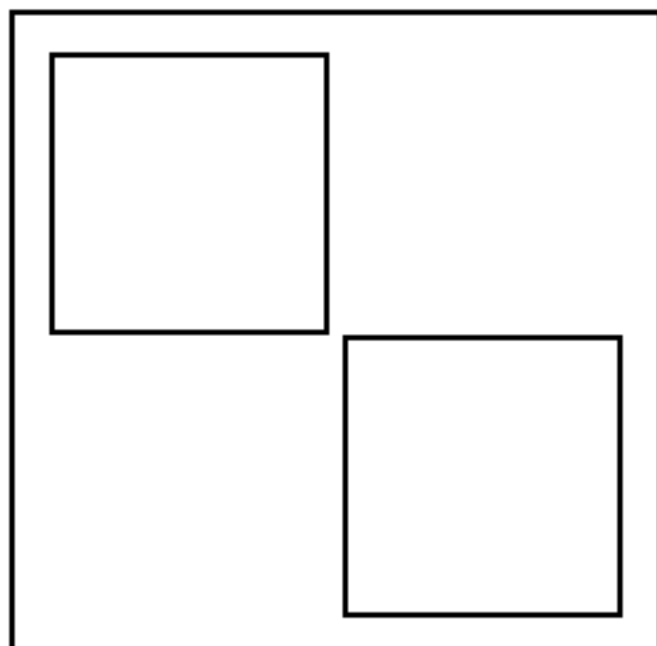
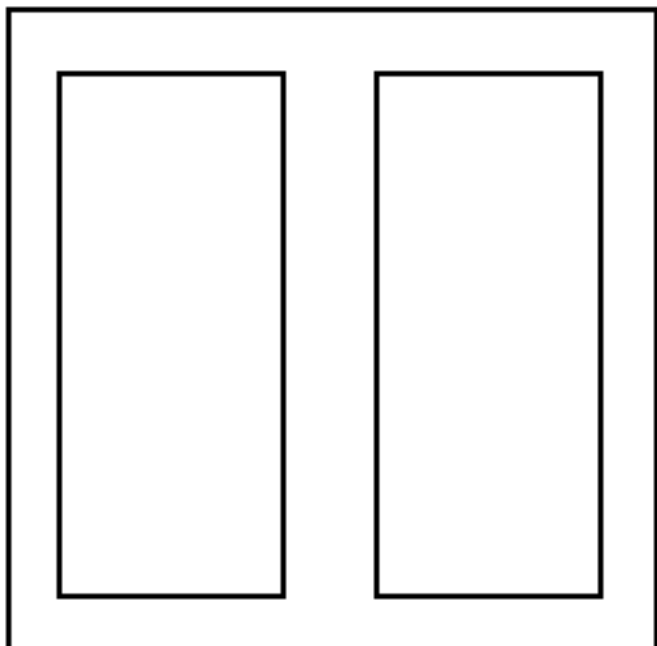

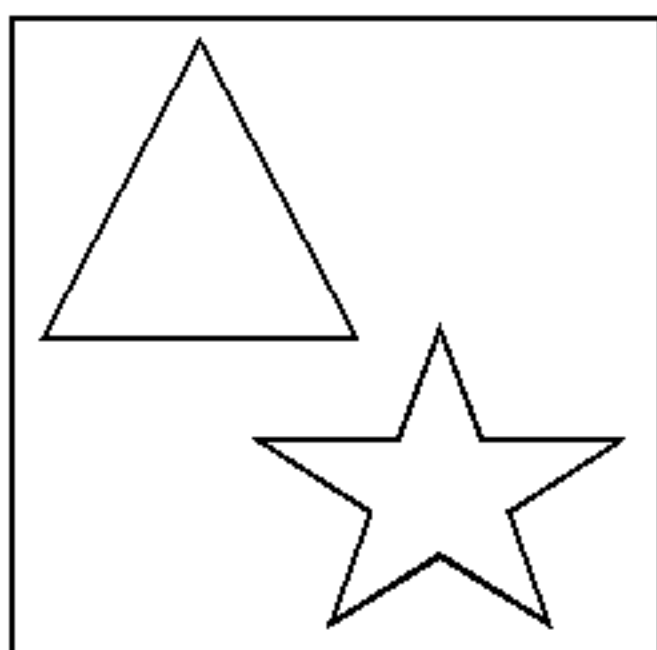
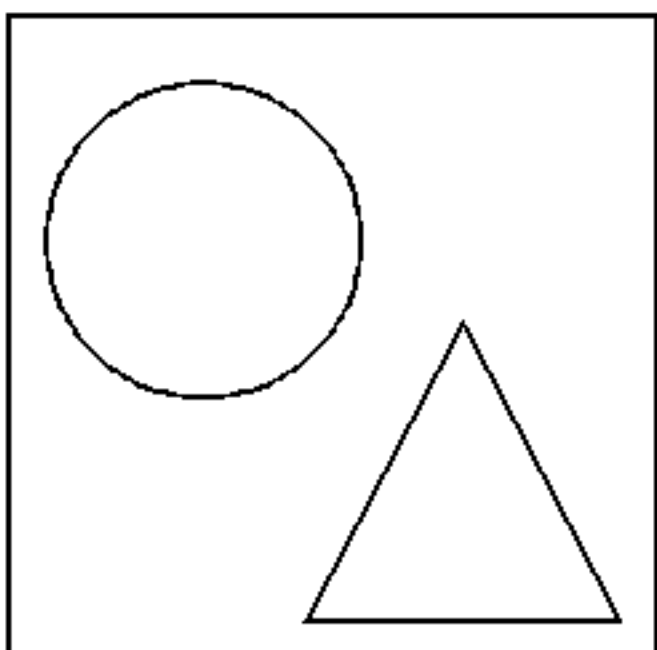
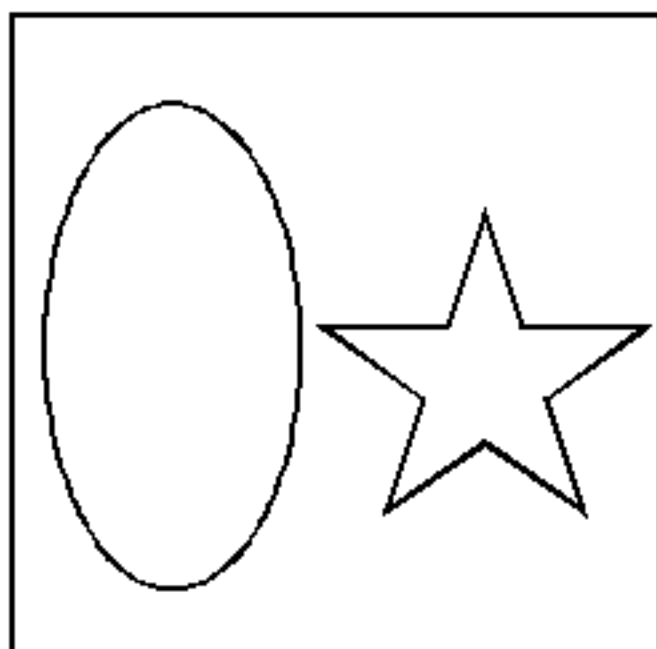
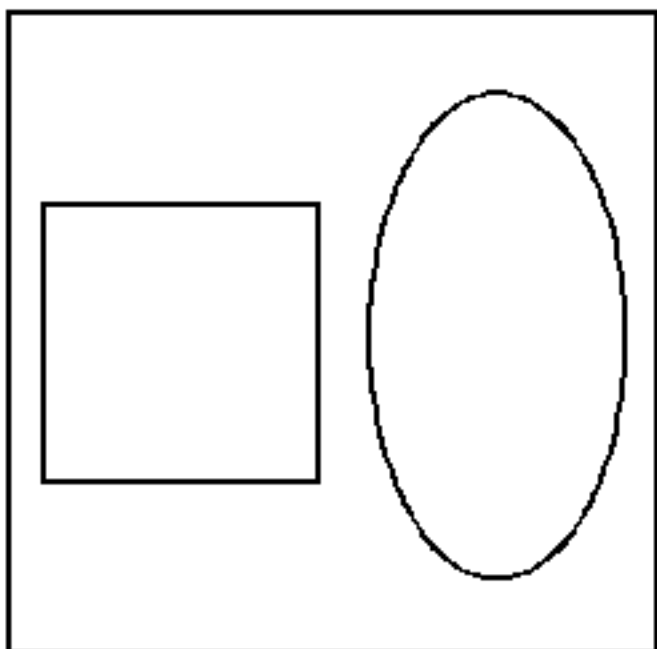
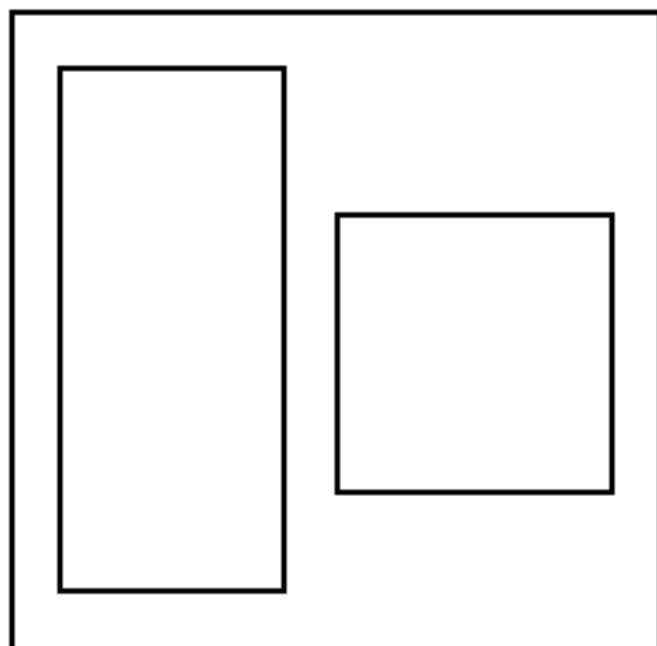
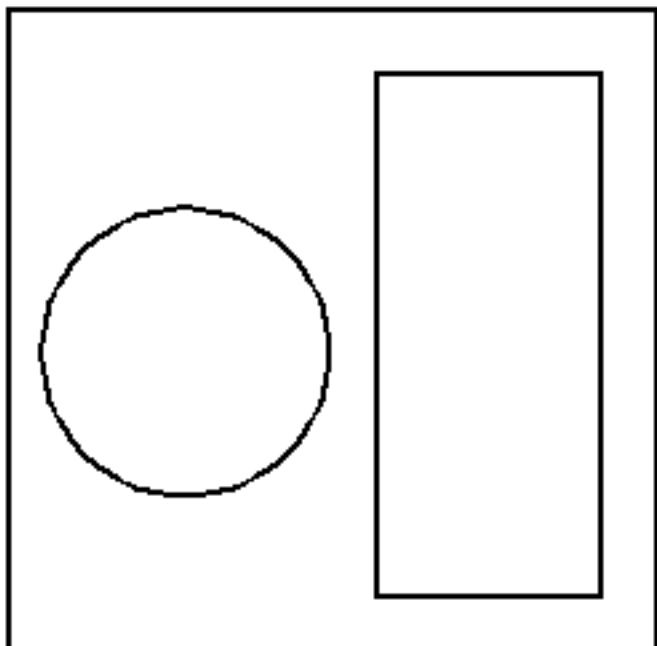

Butterfly Shape Memory Match Game

Instructions: You will need two copies of the shapes. Print as many butterflies as you need on cardstock paper. Print shape squares on regular paper. Cut out butterflies and shape squares. Glue shape squares on the back of the butterflies and laminate. Place butterflies on the floor so the shape squares are facing the floor. Play as a traditional memory game. For younger children put fewer butterflies down to match.

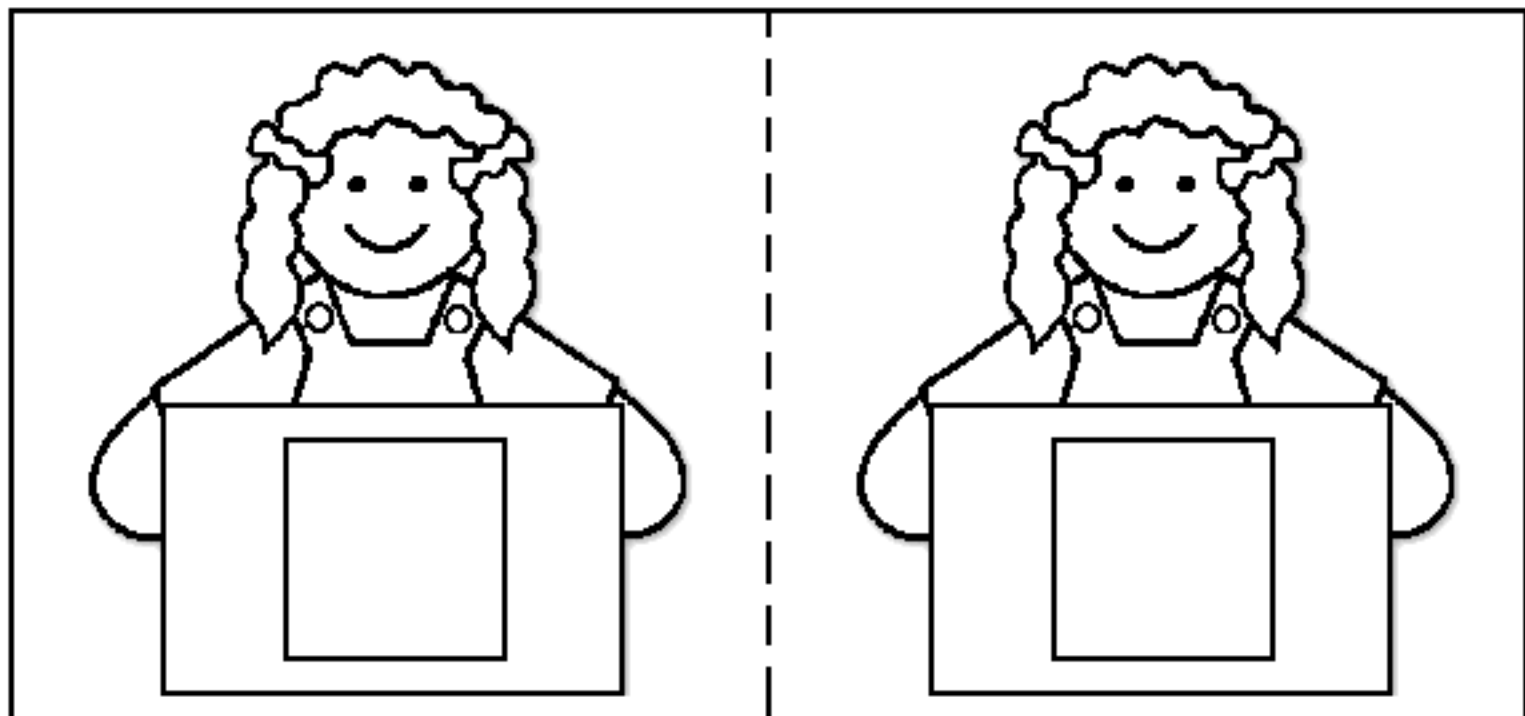
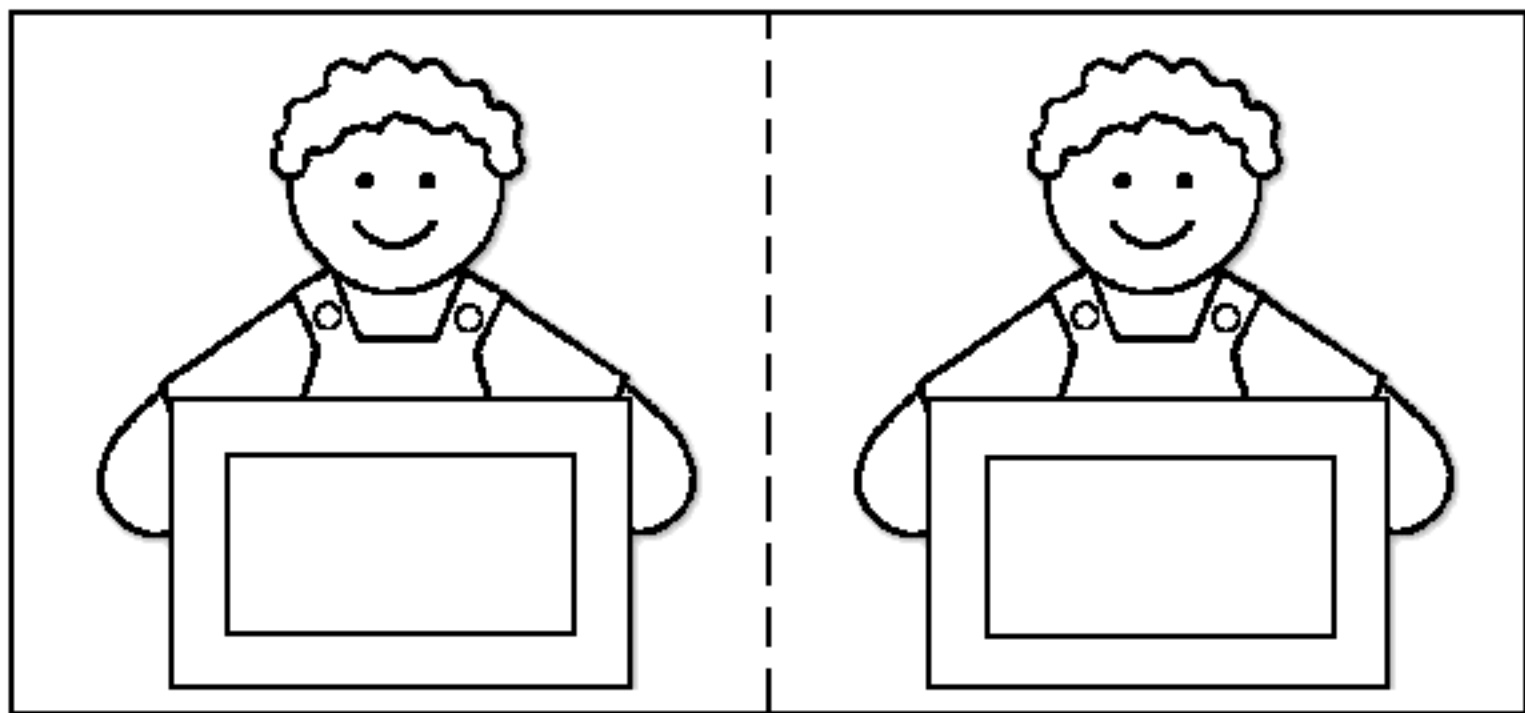

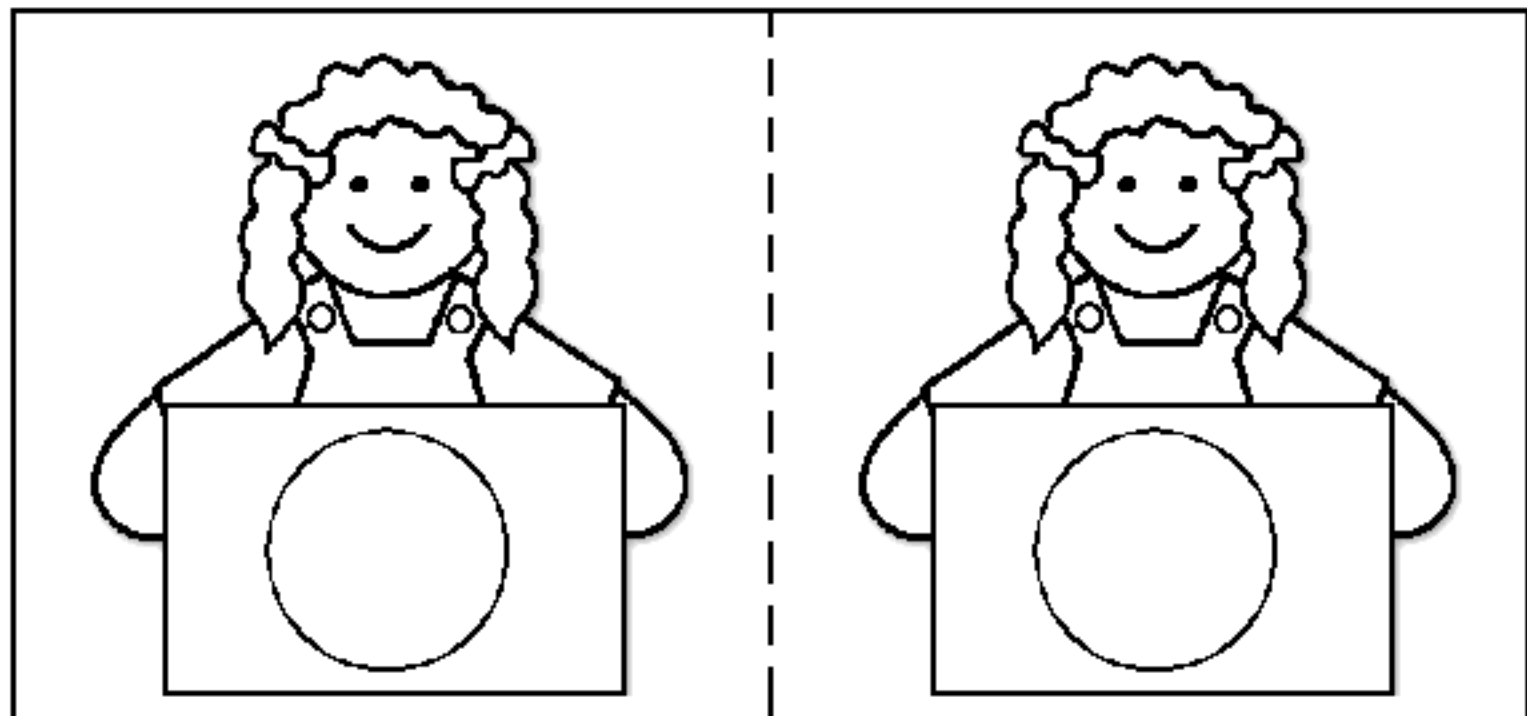
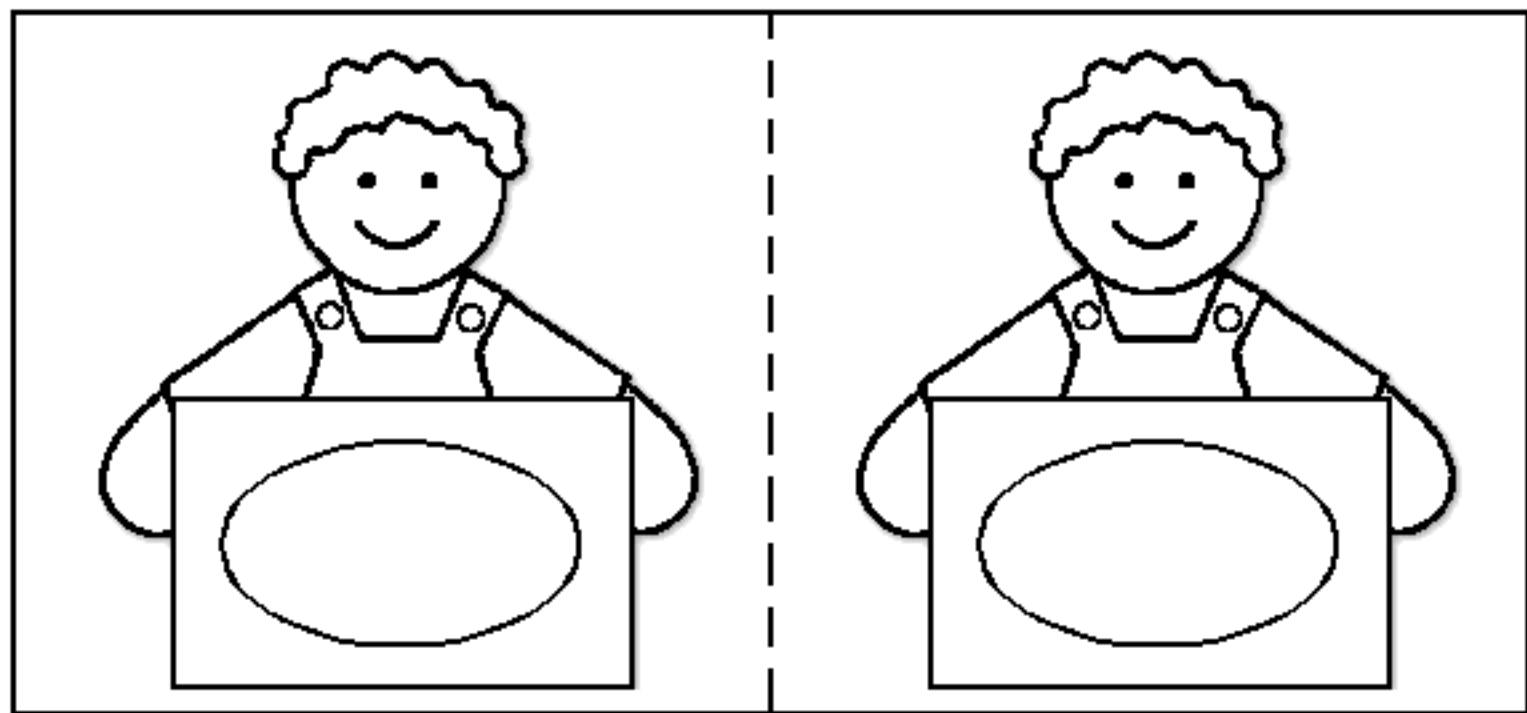

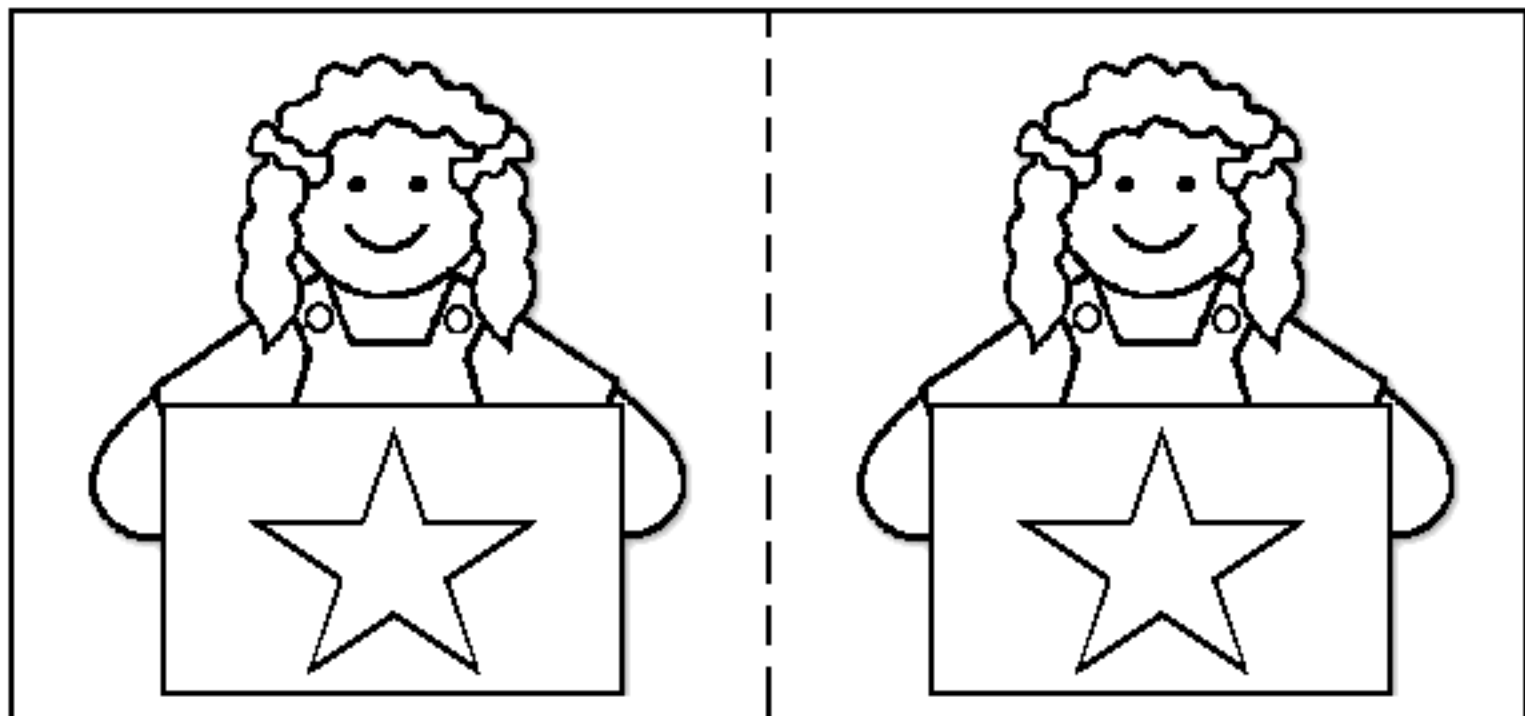
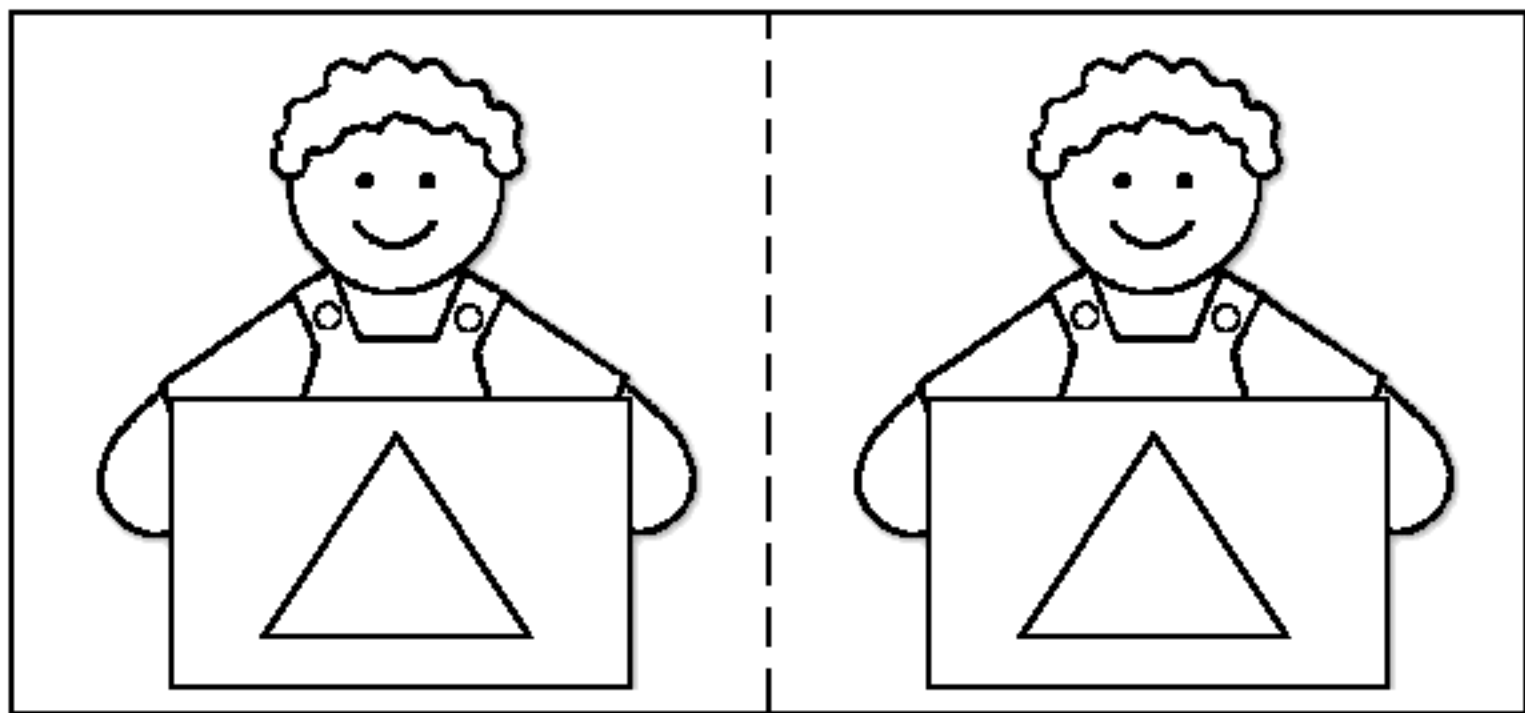

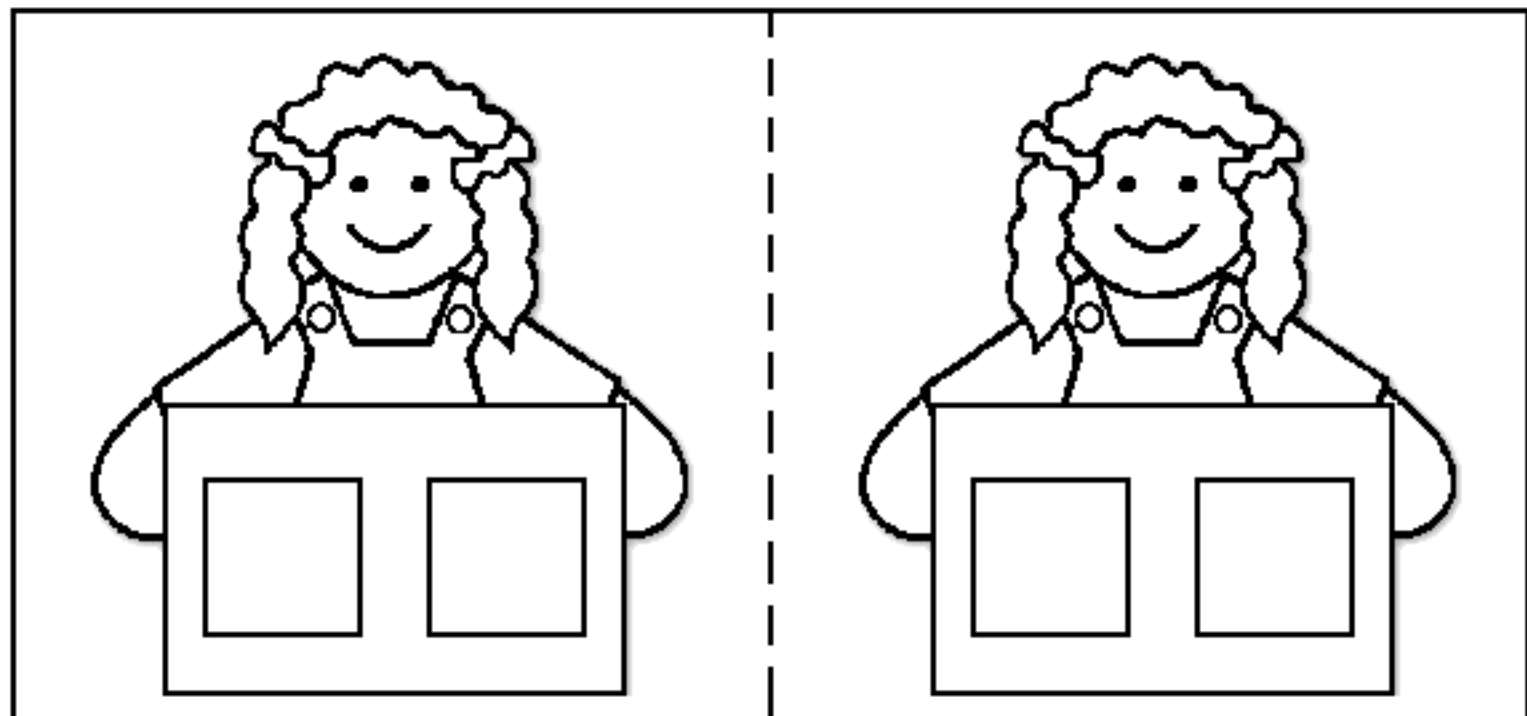
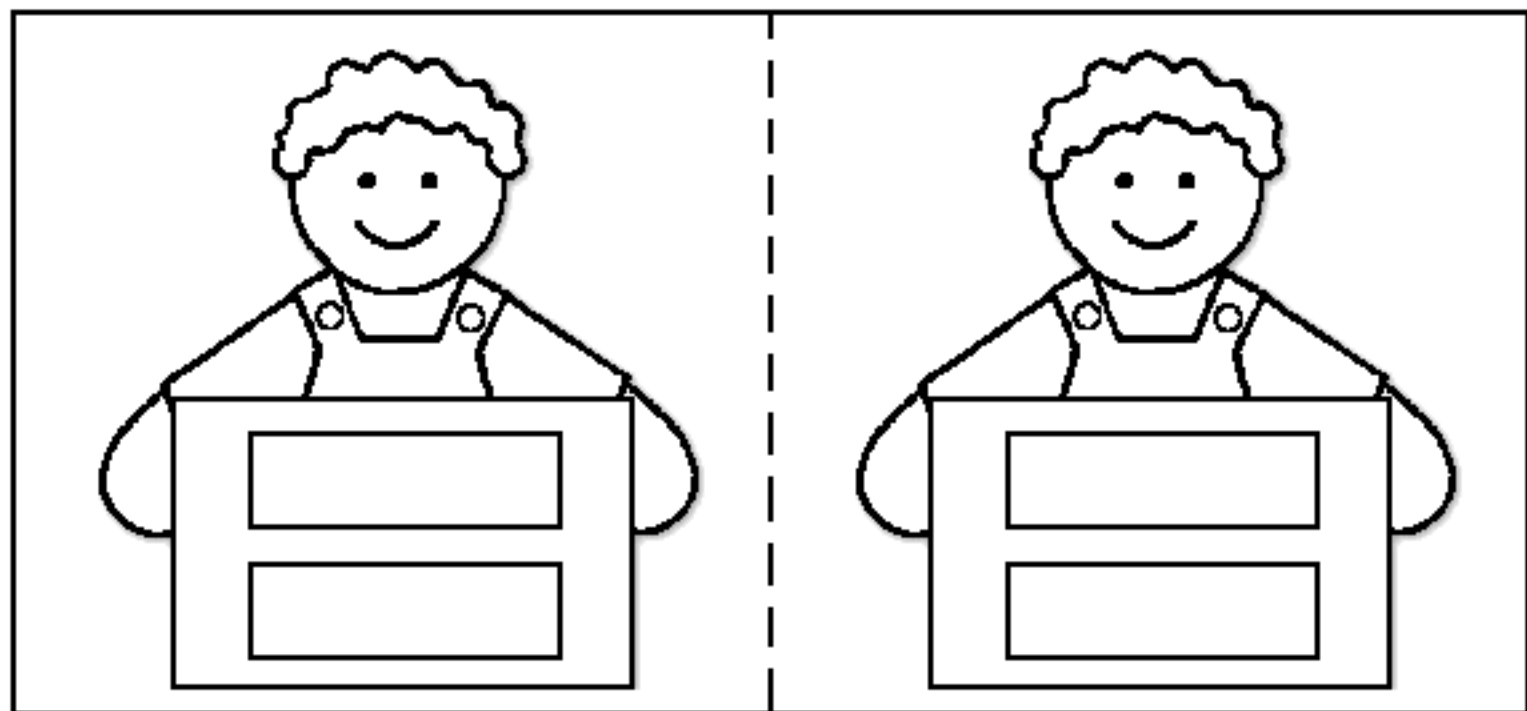

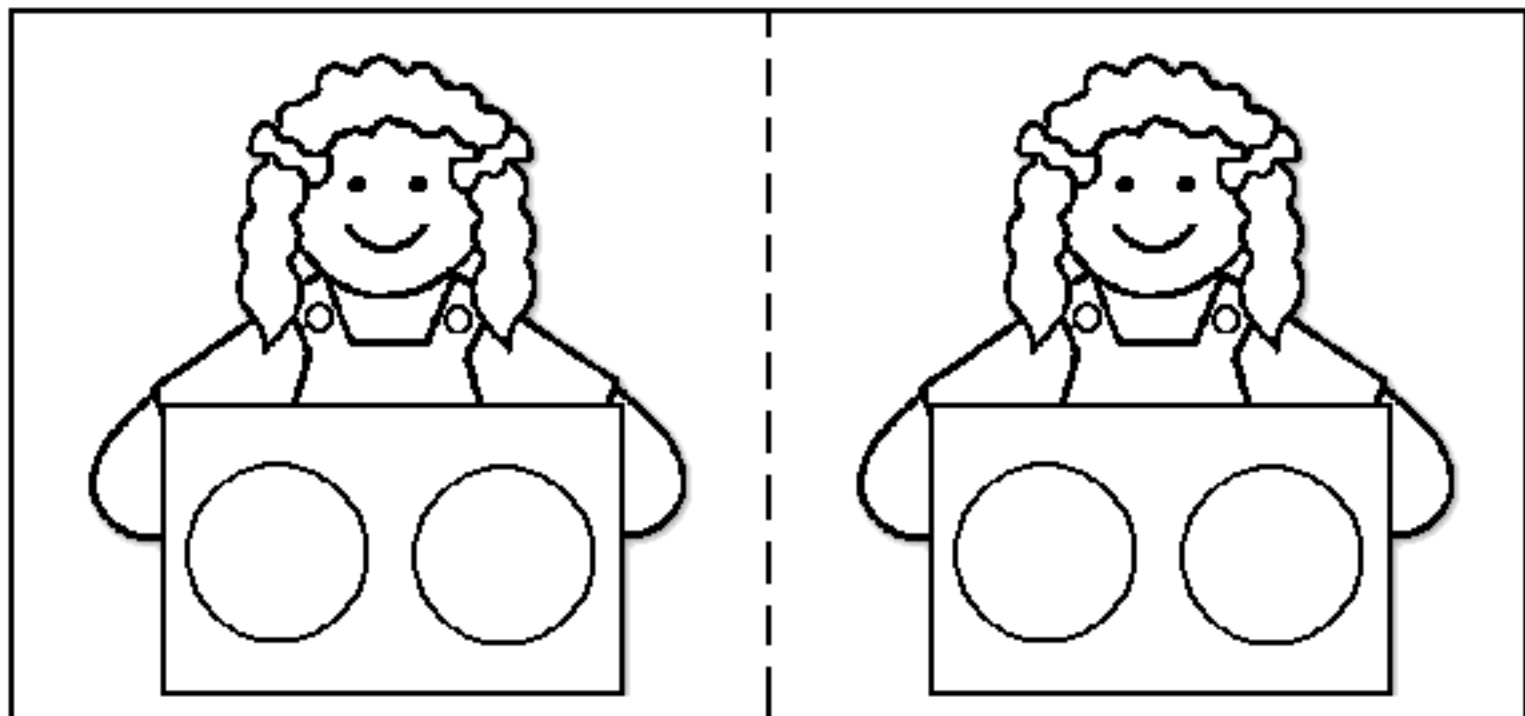
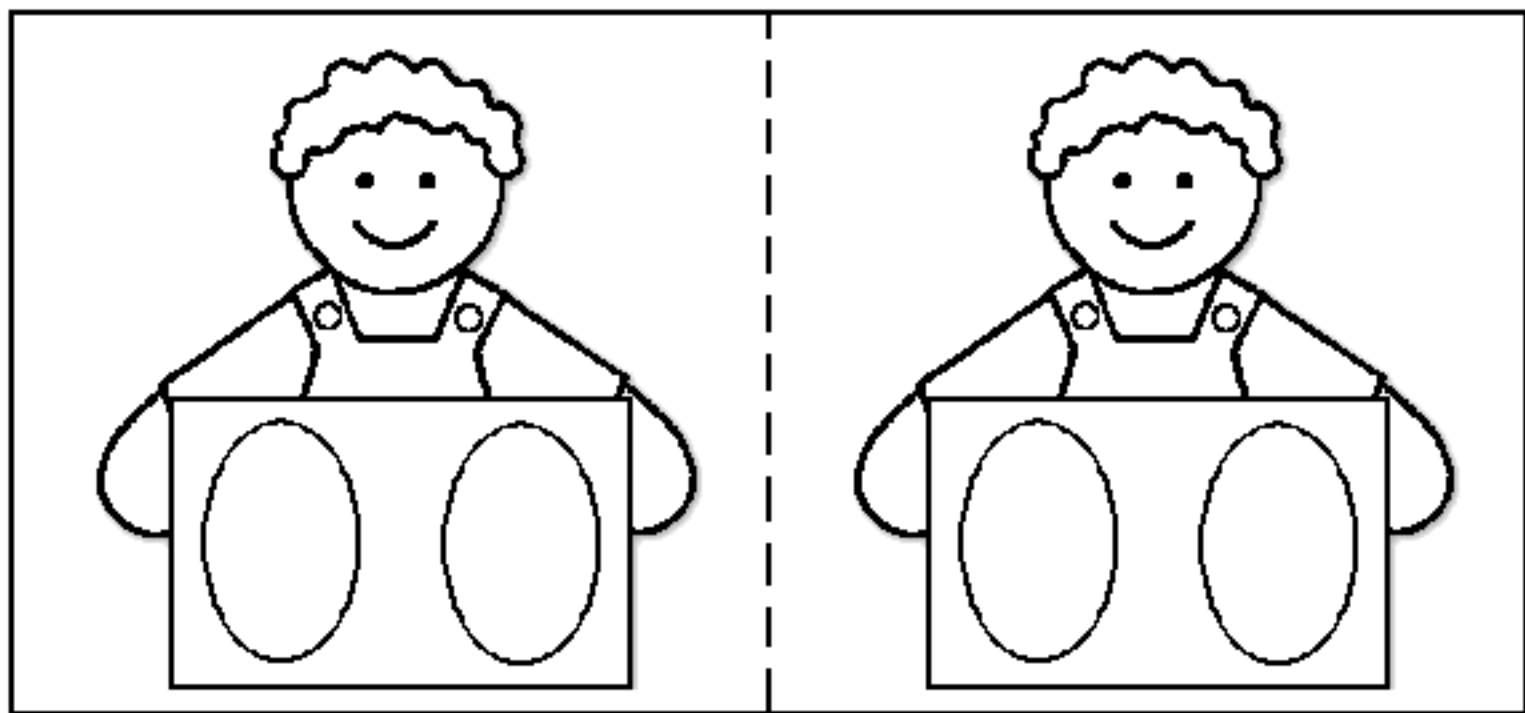

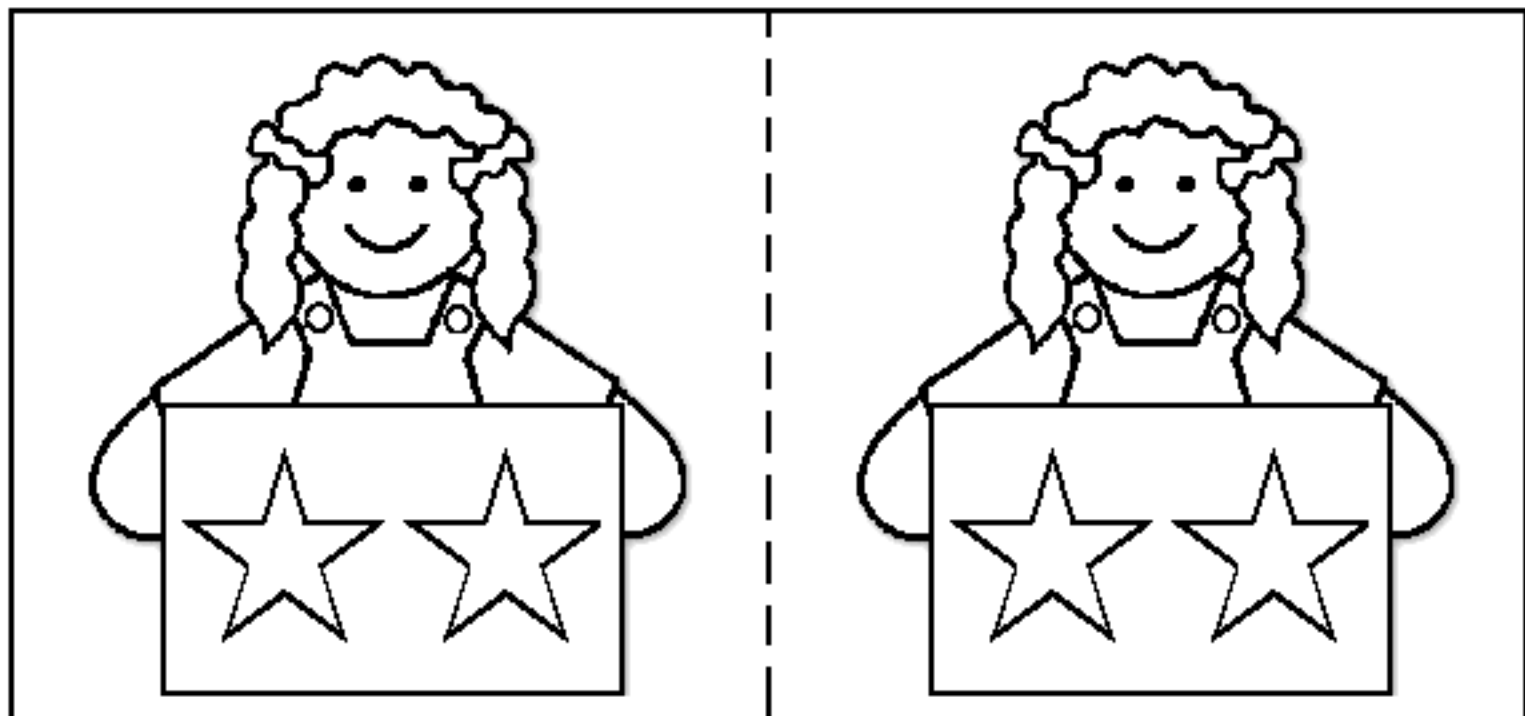
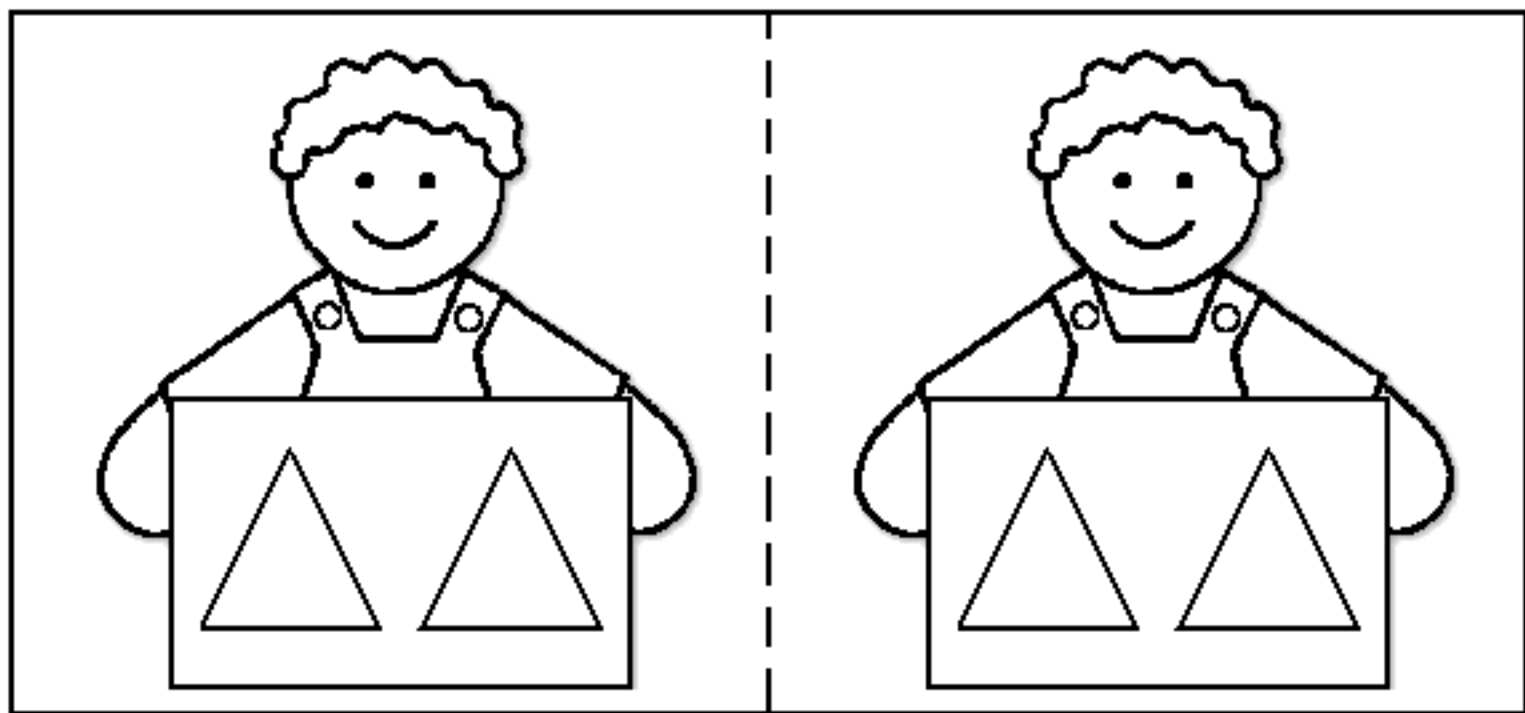

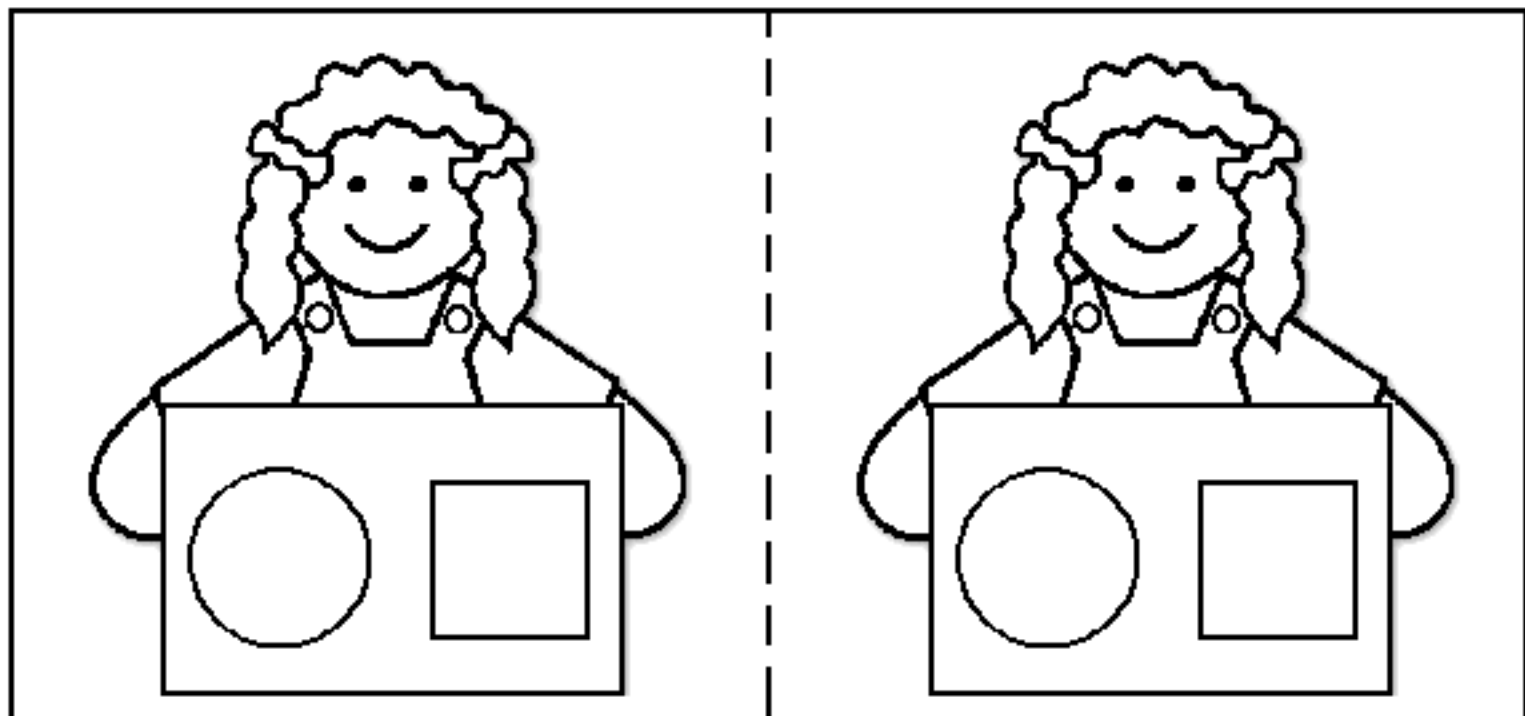
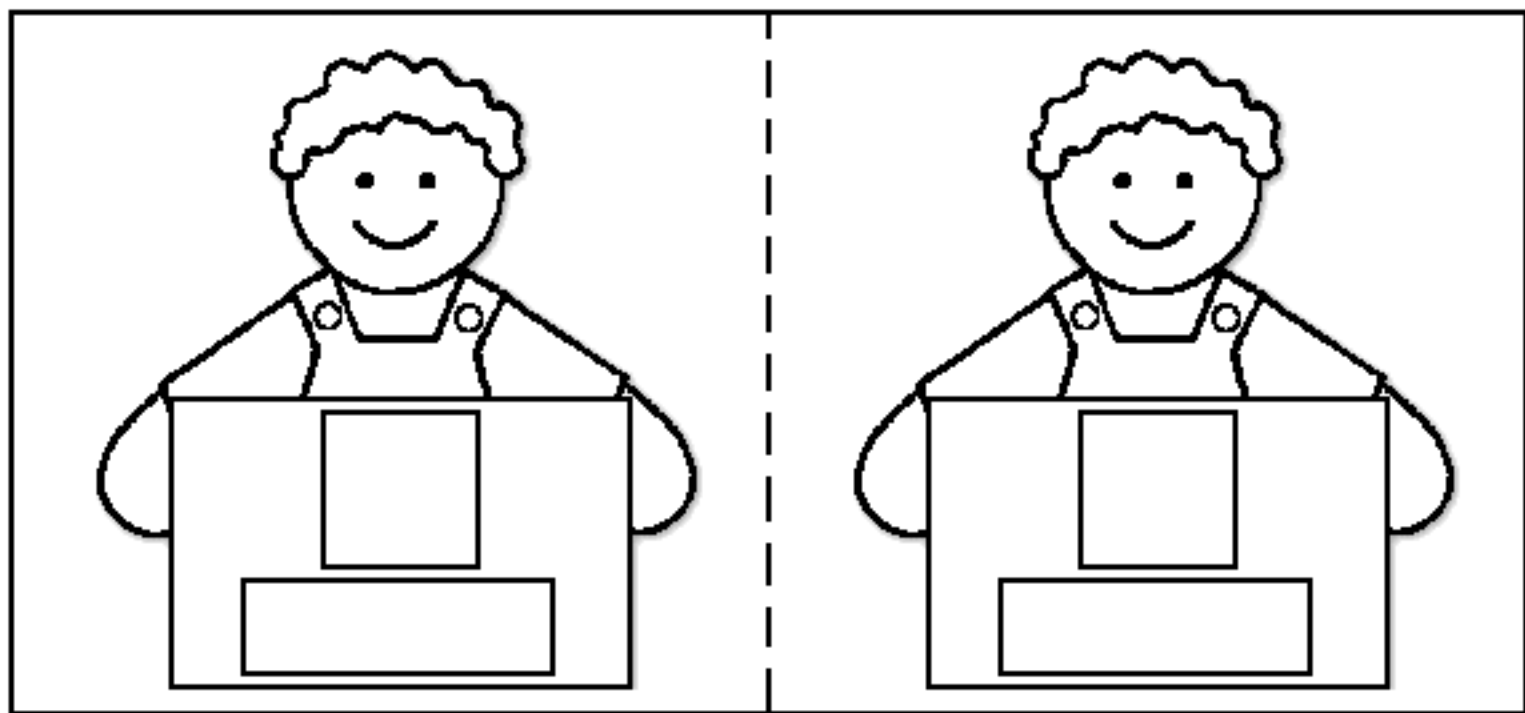

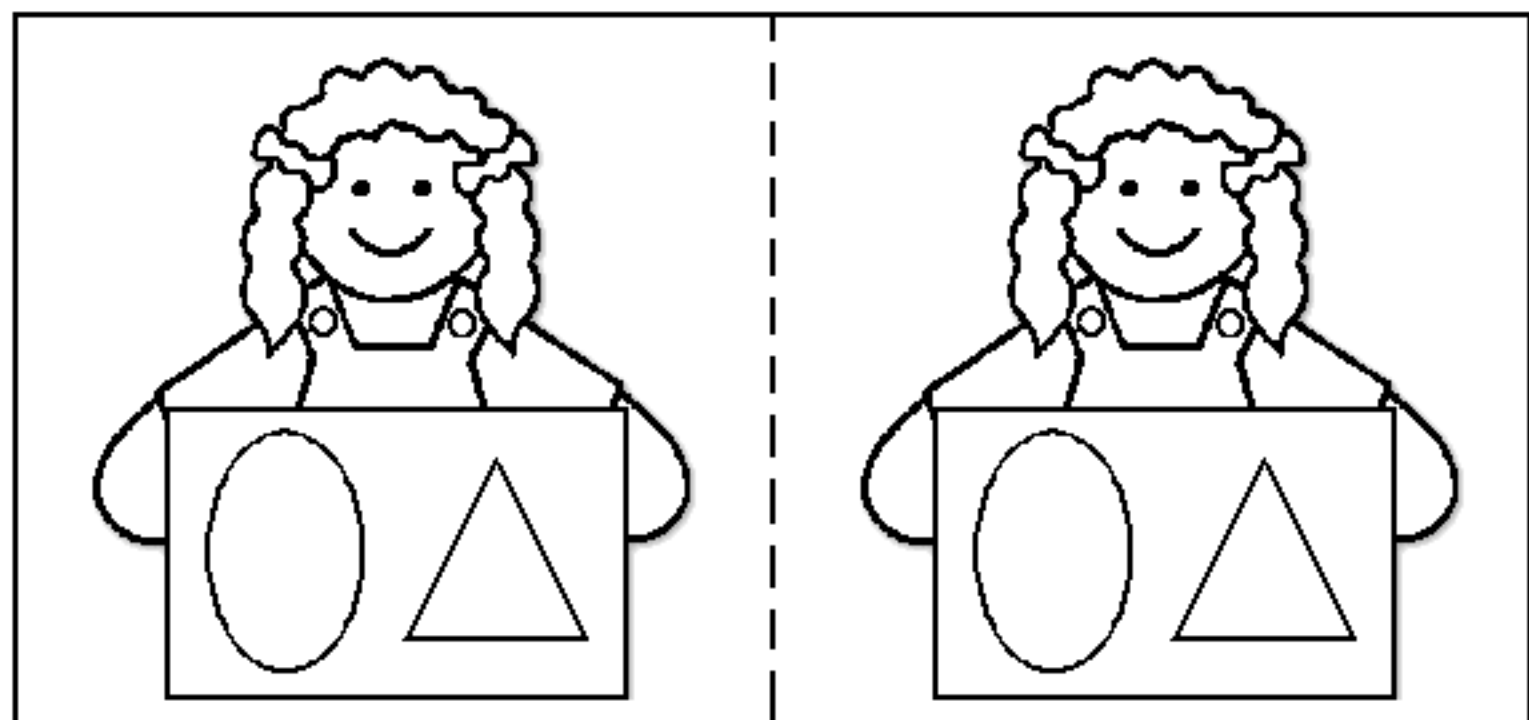
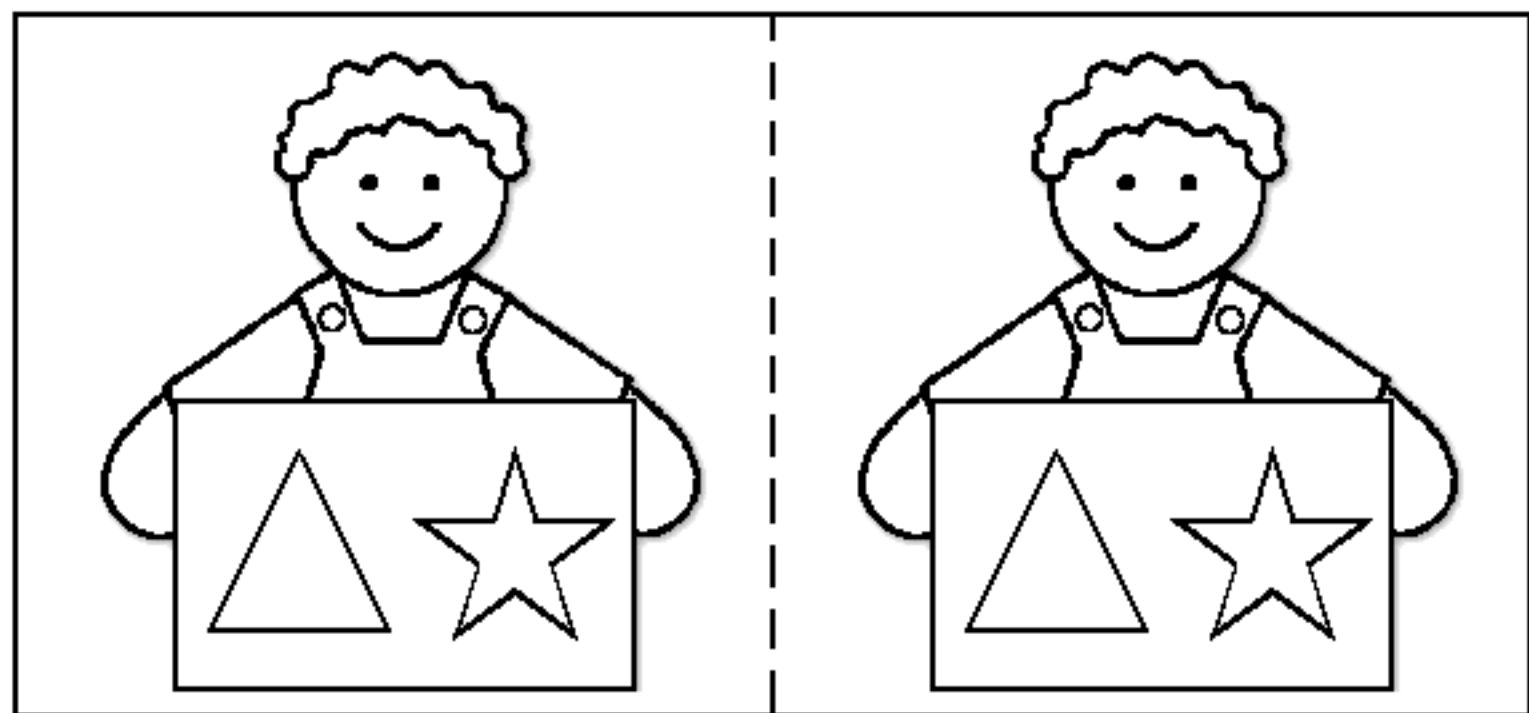

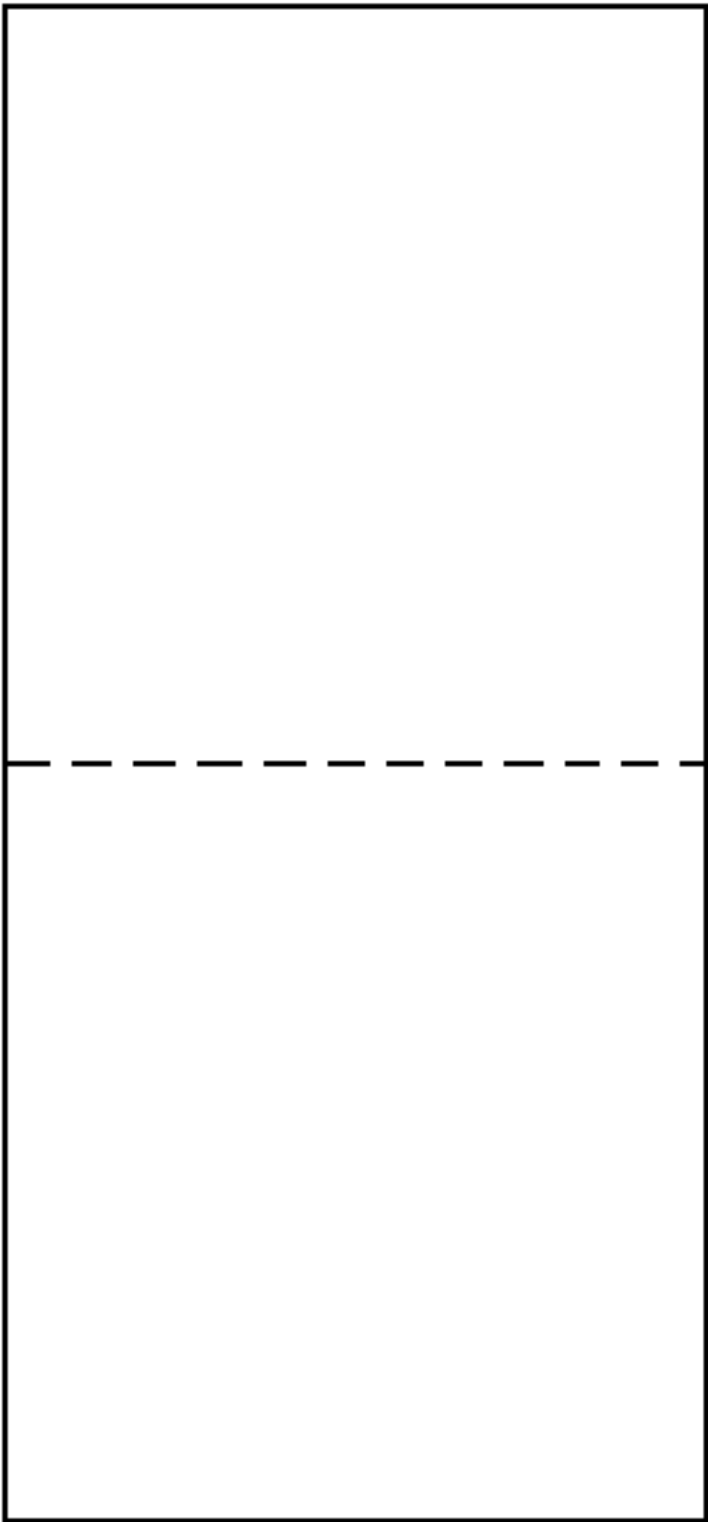

Fall Learning Friends Shape Puzzles

Instructions: Print on cardstock ... cut along dashed lines and laminate. Match the two halves with the same shapes. I have also included a puzzle mat that you can attach velcro to hold the pieces on or children can just set the pieces on the mat.

childcareland.com

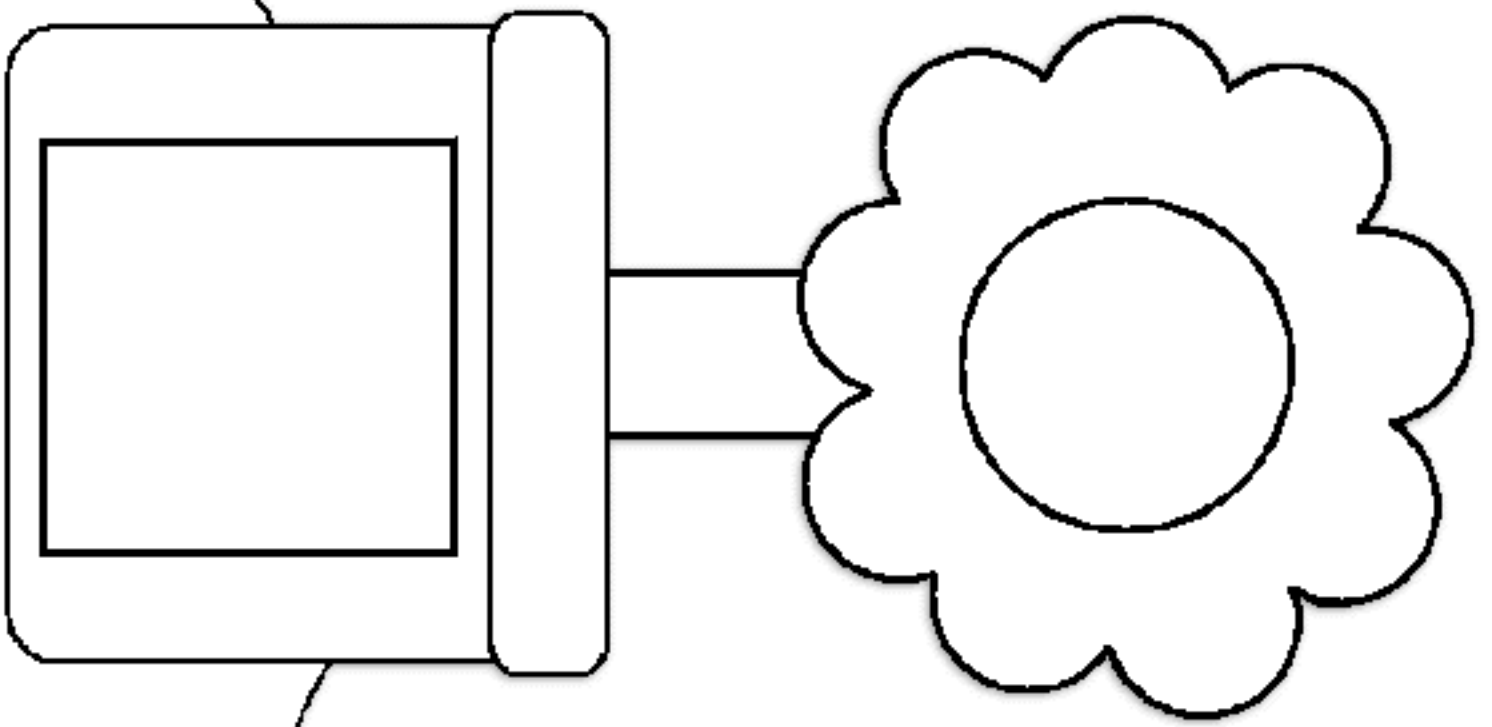
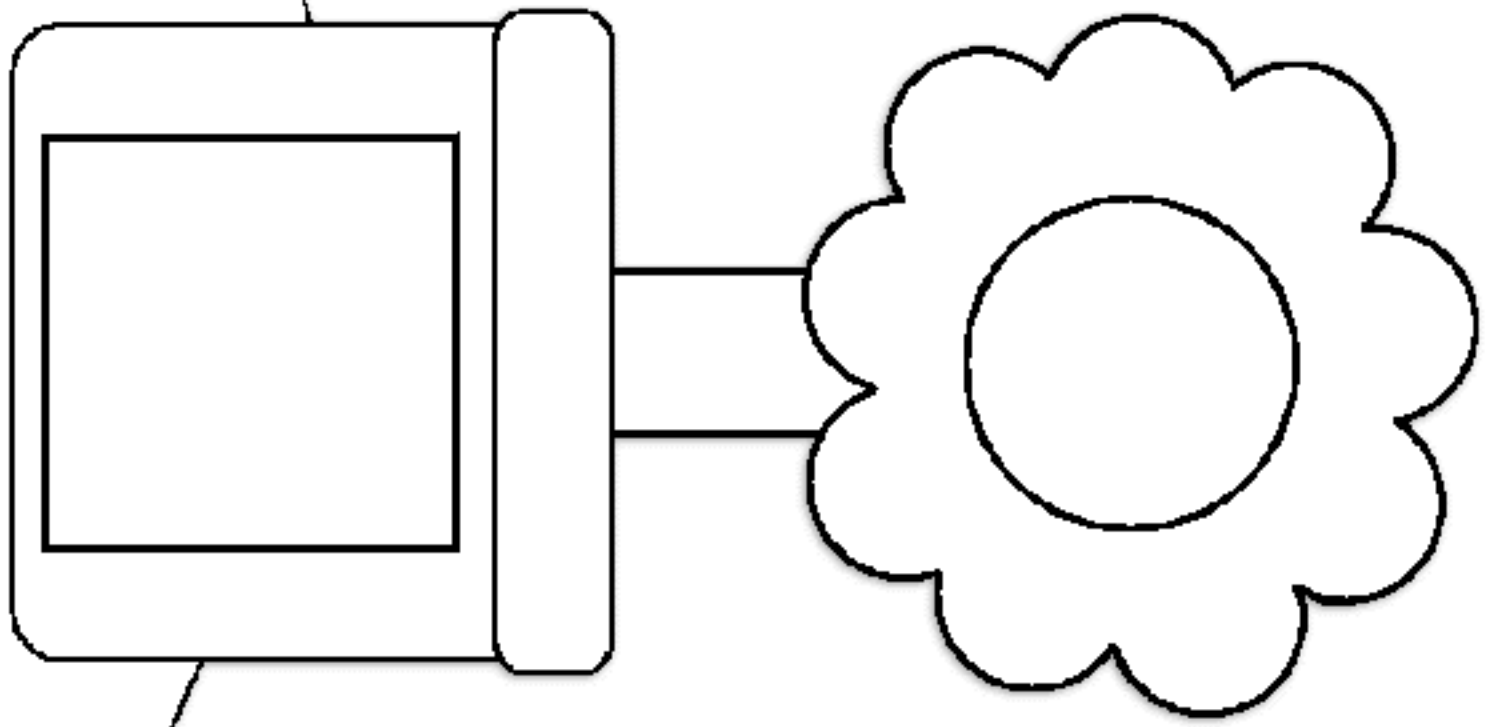

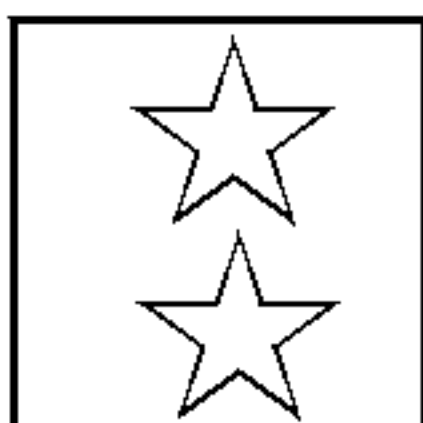
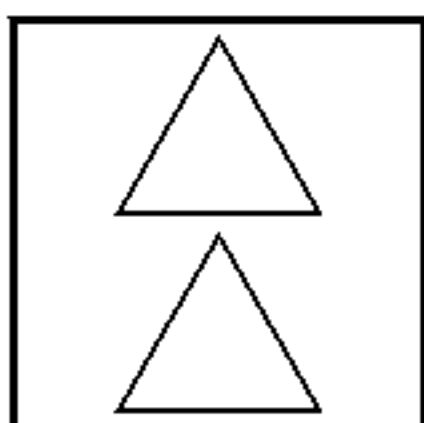
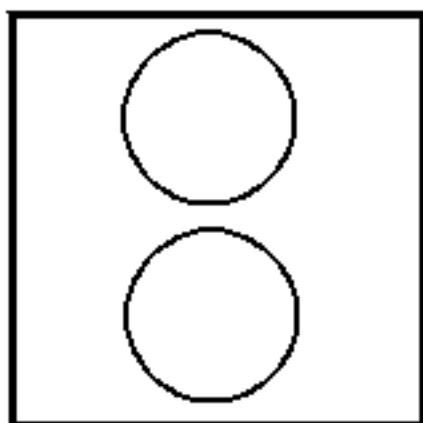
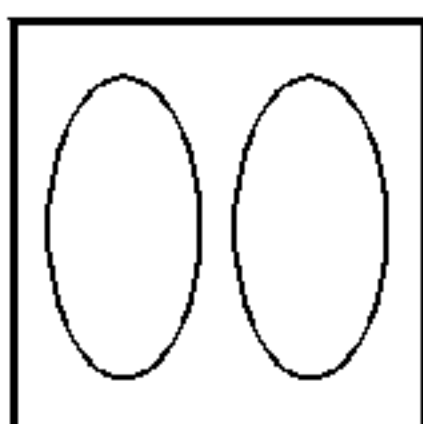
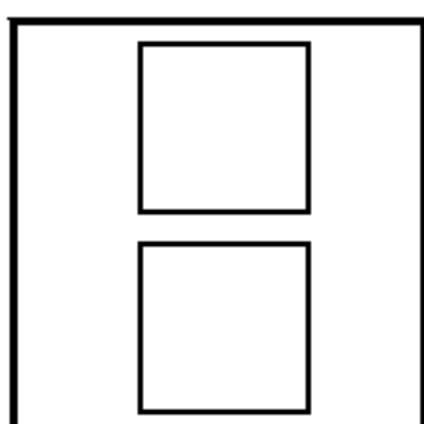
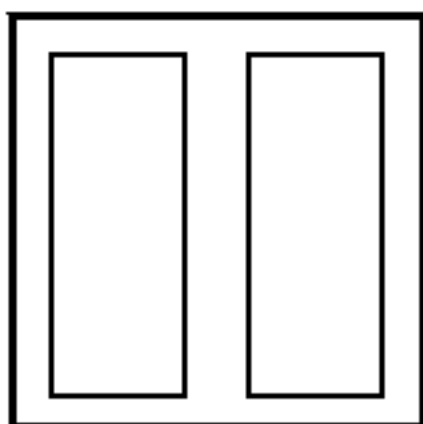
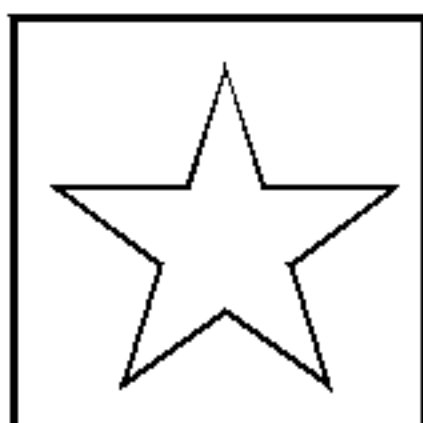
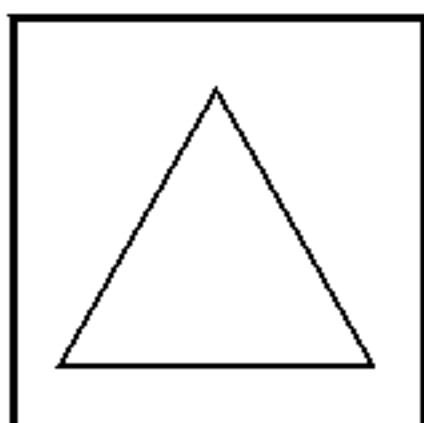
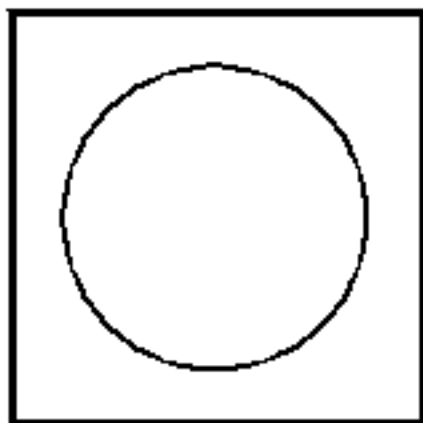
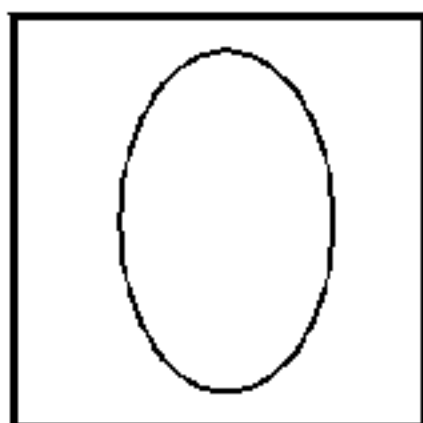
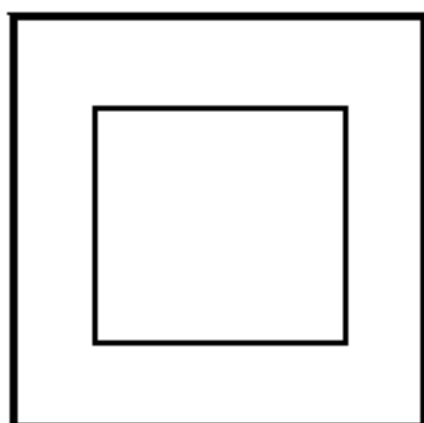
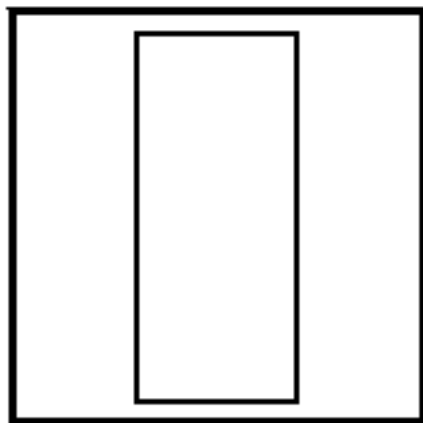

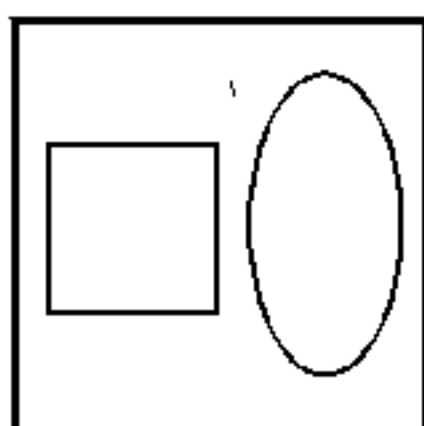
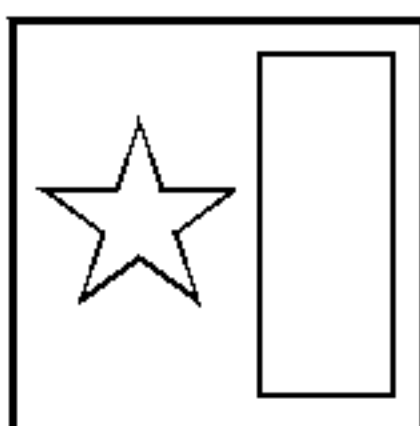
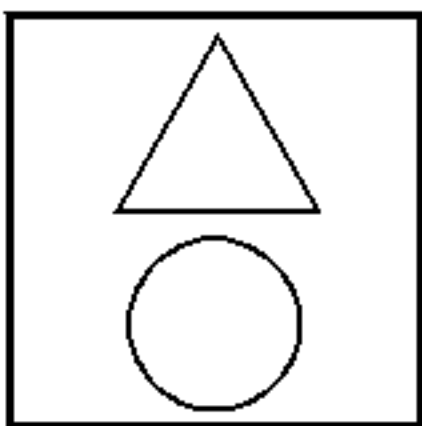
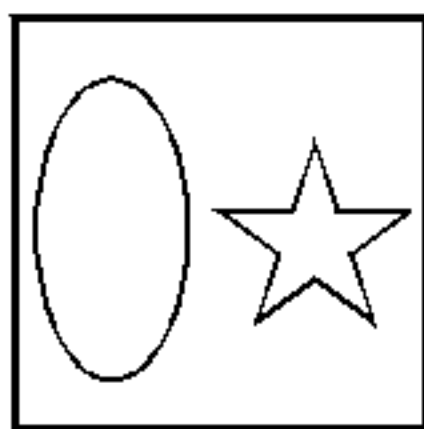
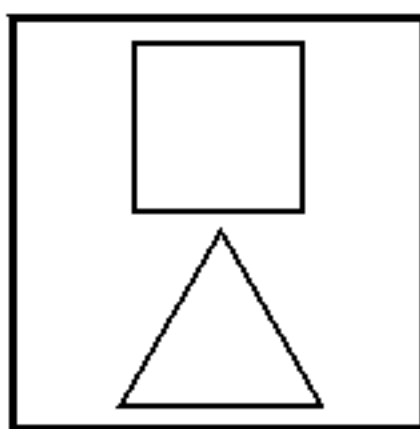
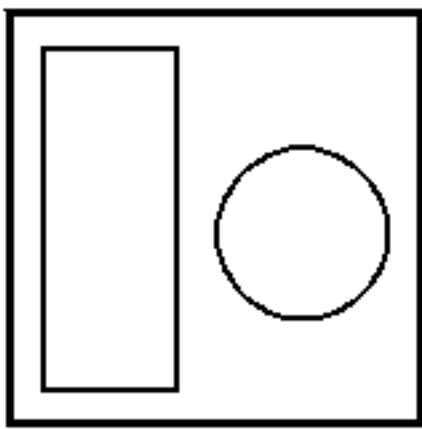

Instructions: Print matching boards on cardstock paper and laminate. Print shape cards on cardstock paper... cut out and laminate. Store shape cards in a zip-lock bag.

Place a shape on the left square on the matching board and find the correct shape to match it and put it on the right square on the matching board.

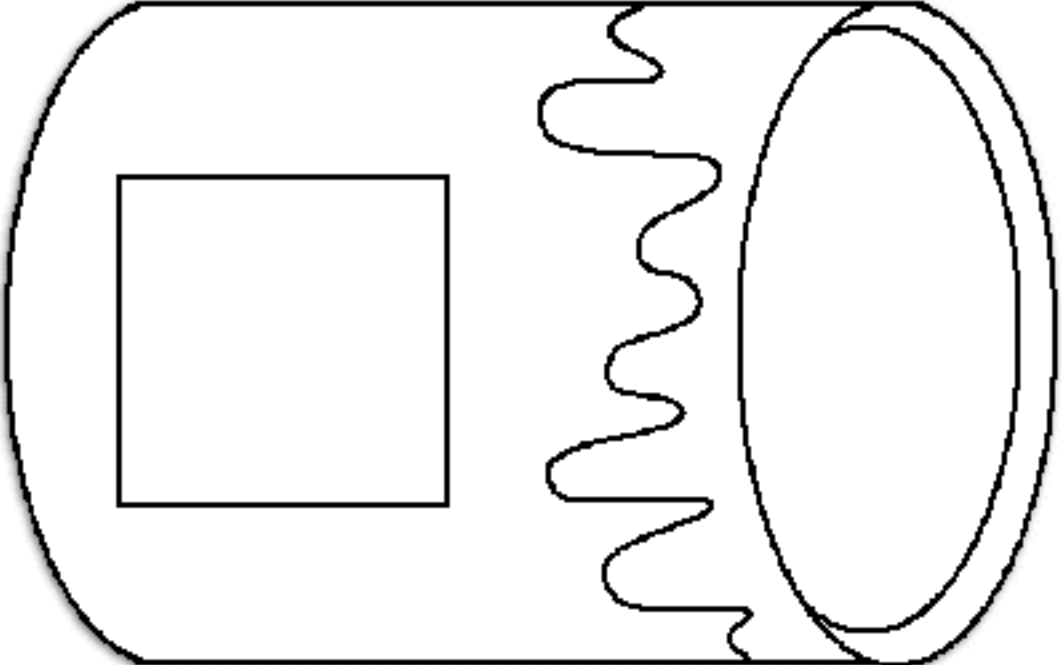
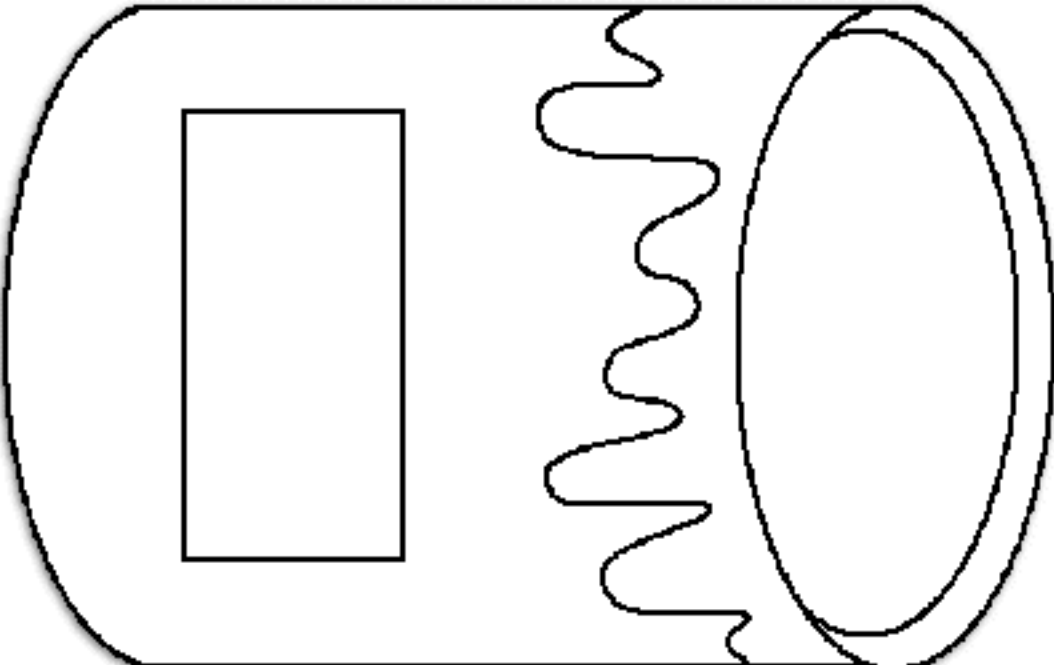
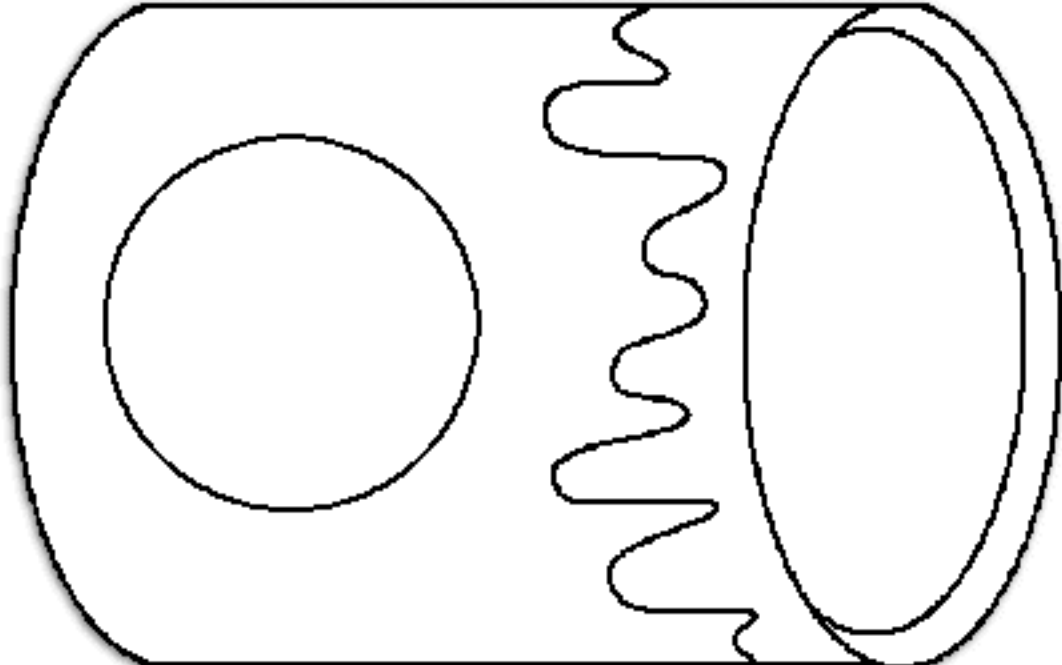

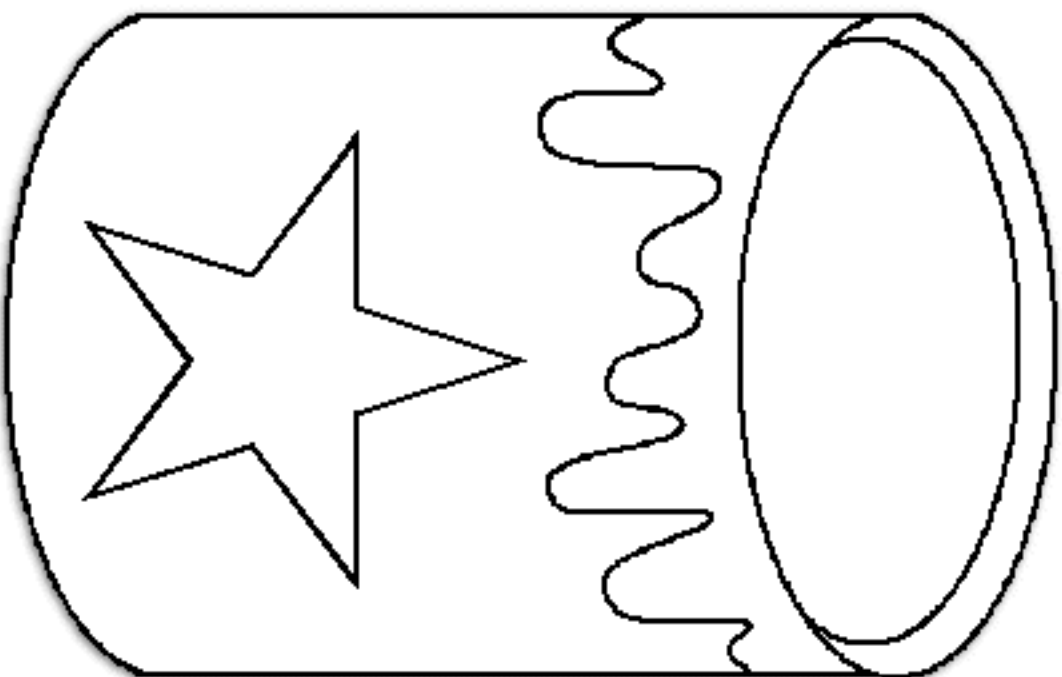
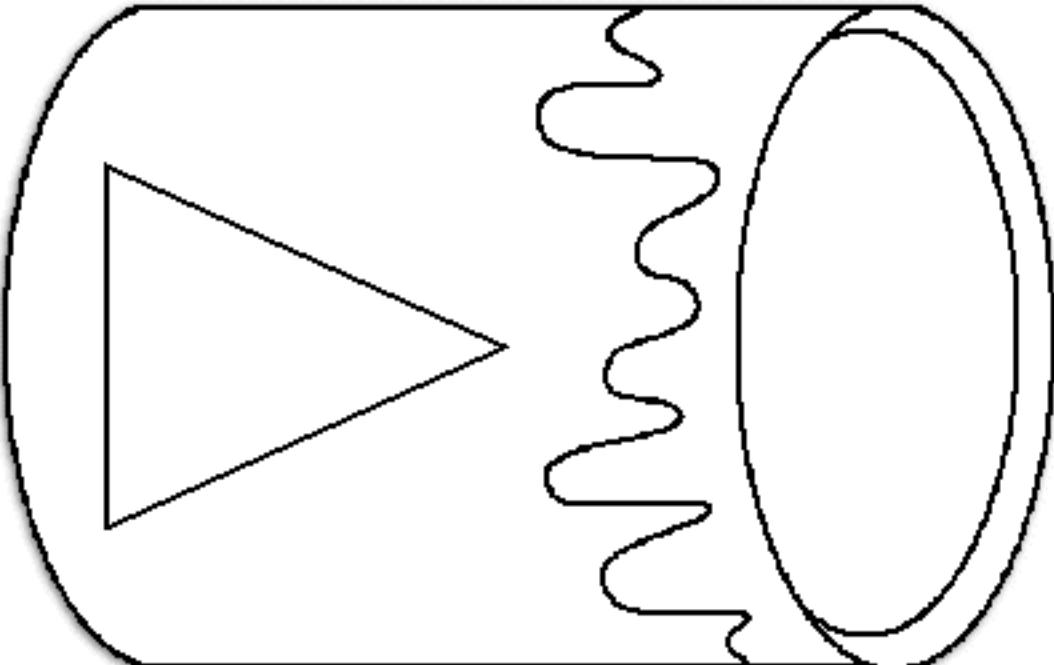
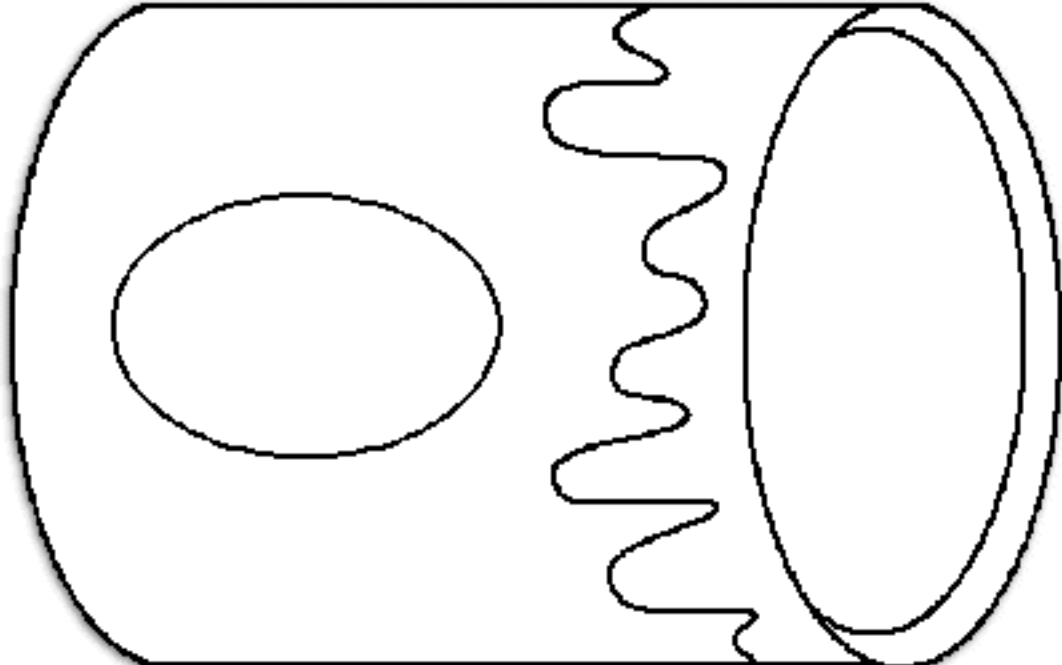

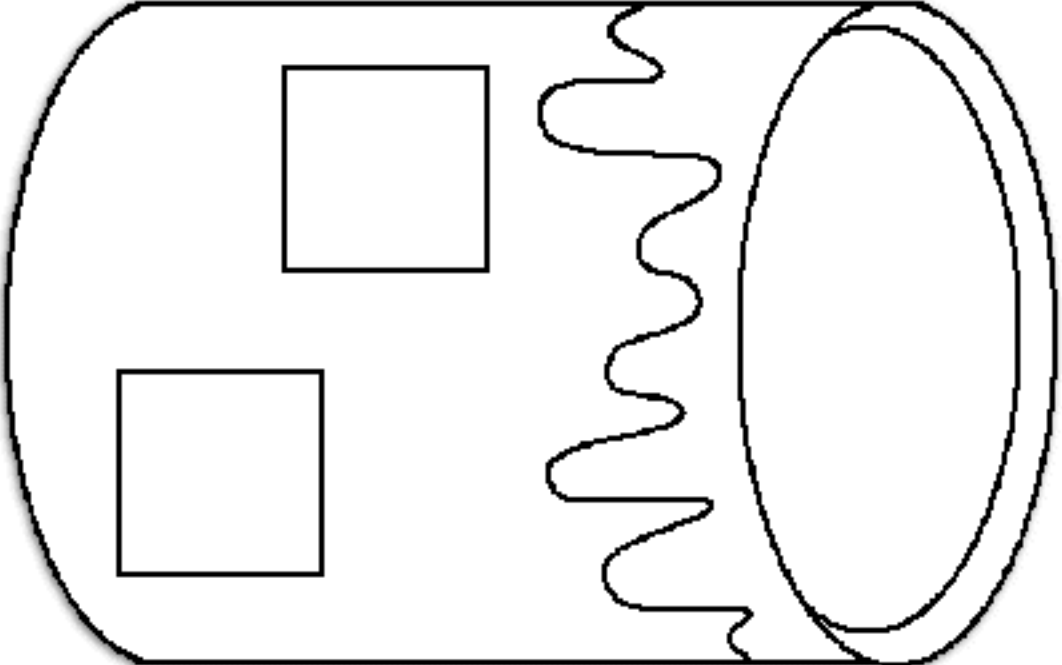
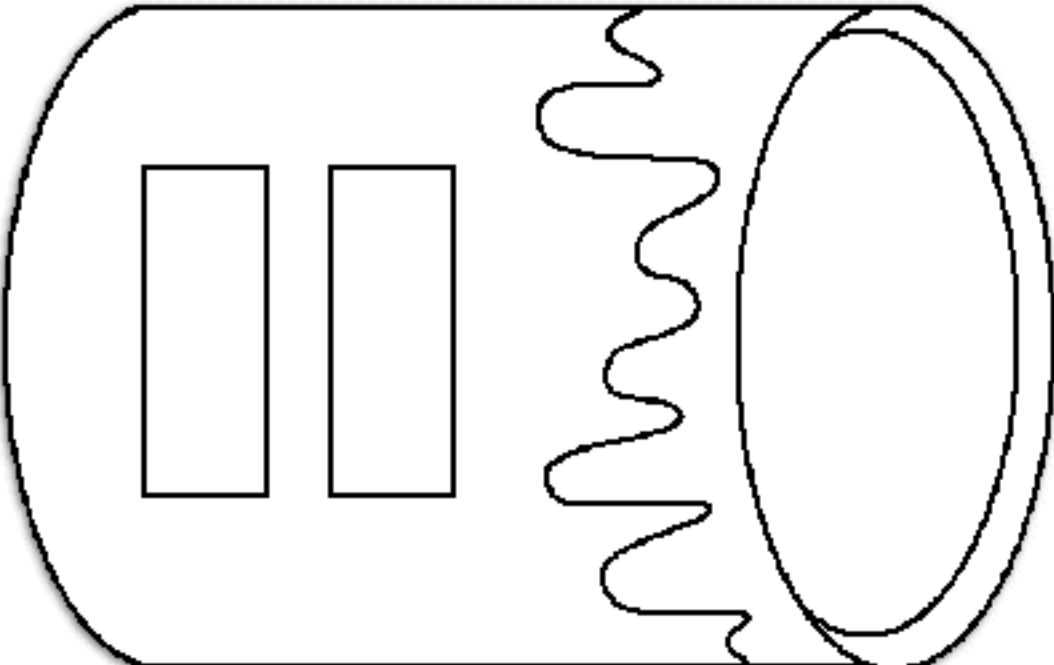
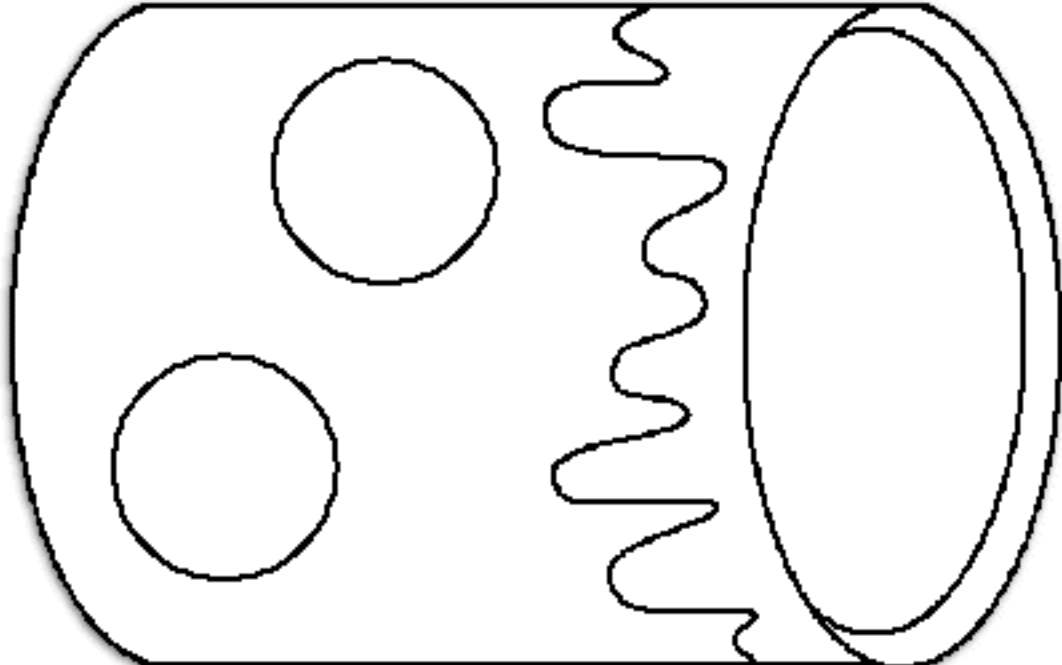

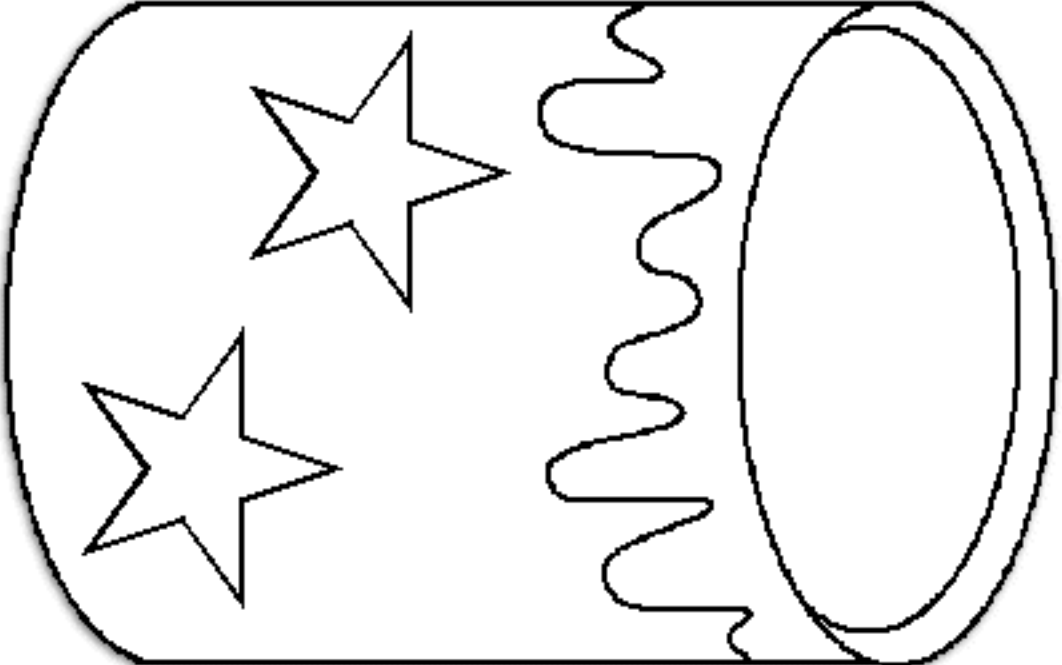
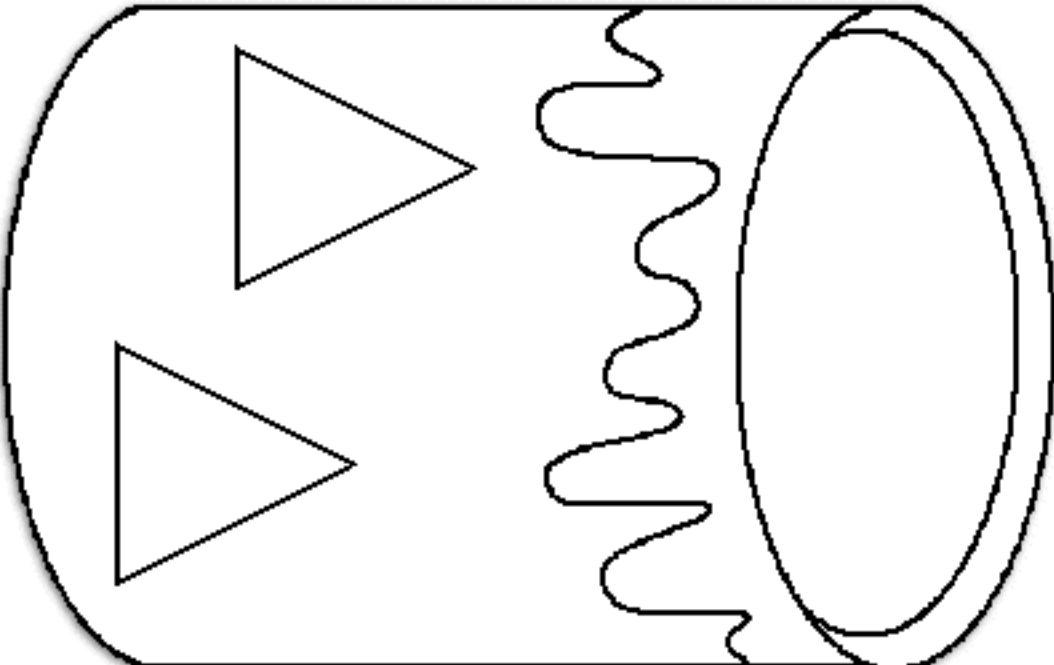
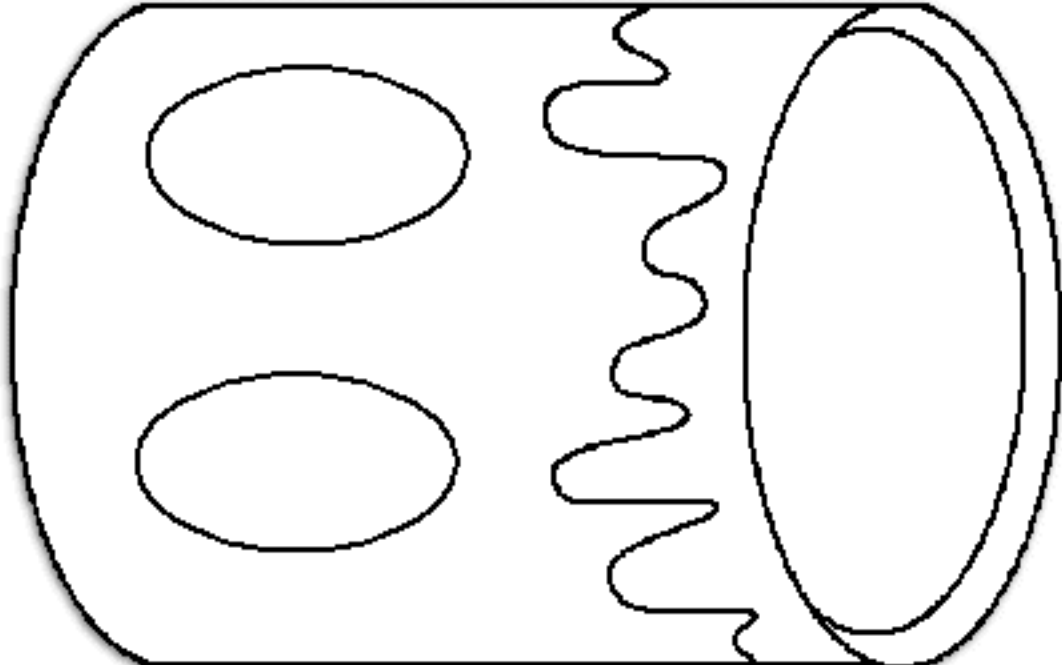

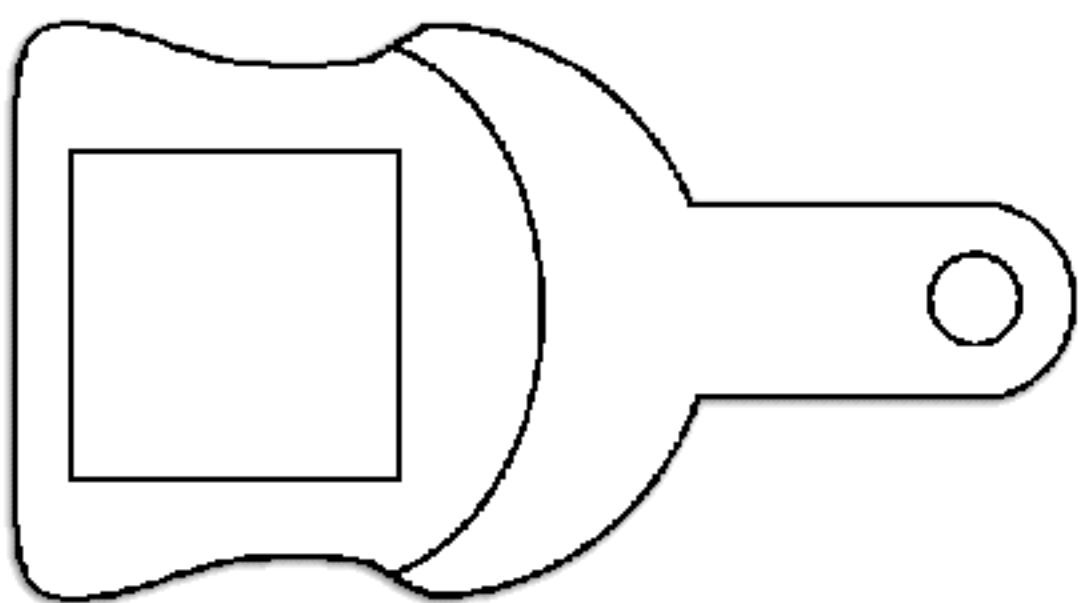
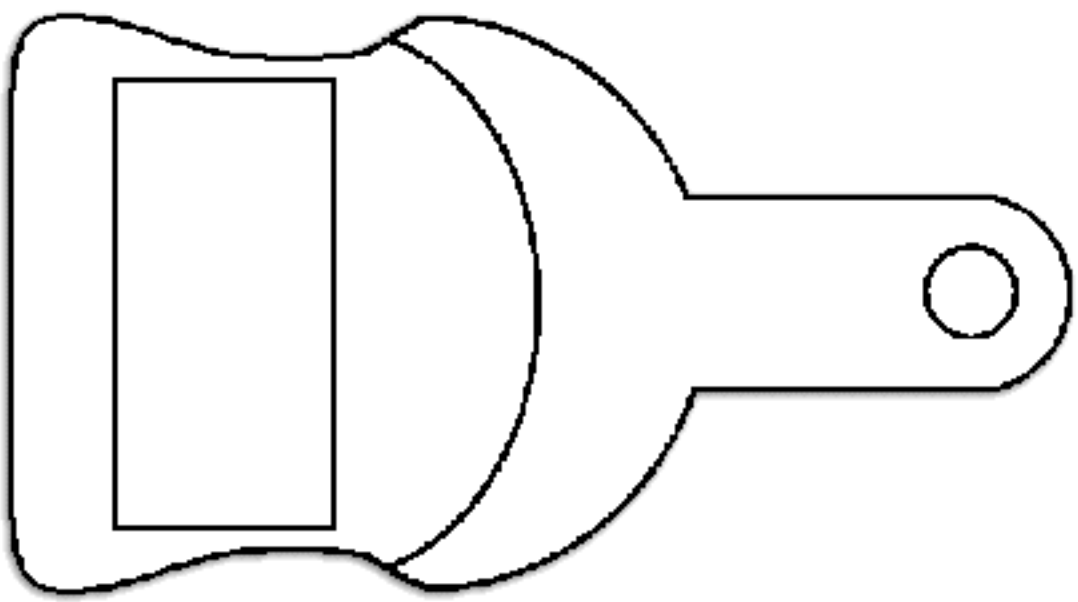
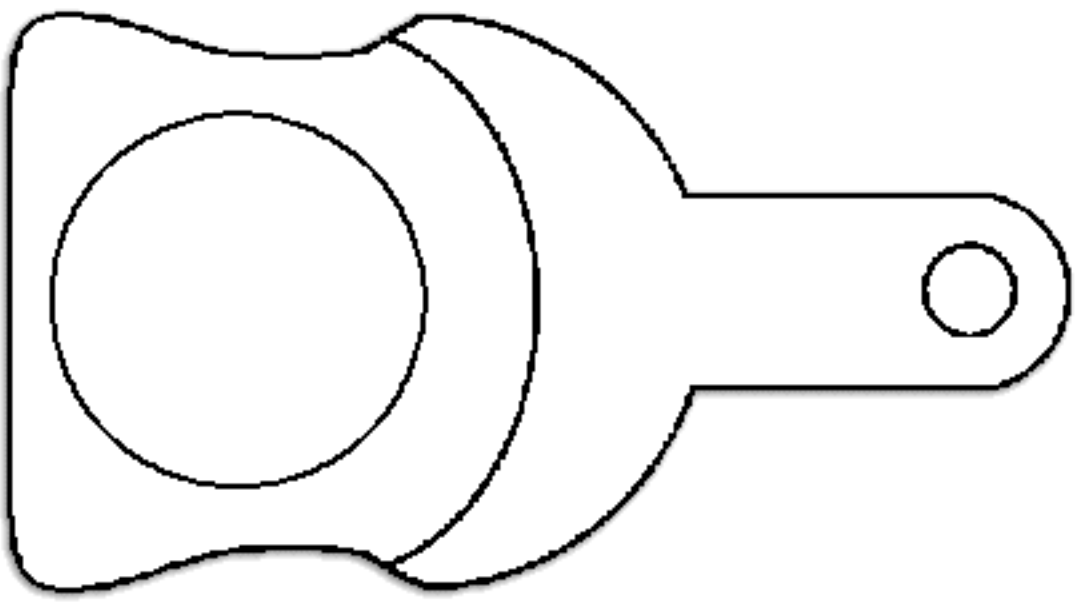

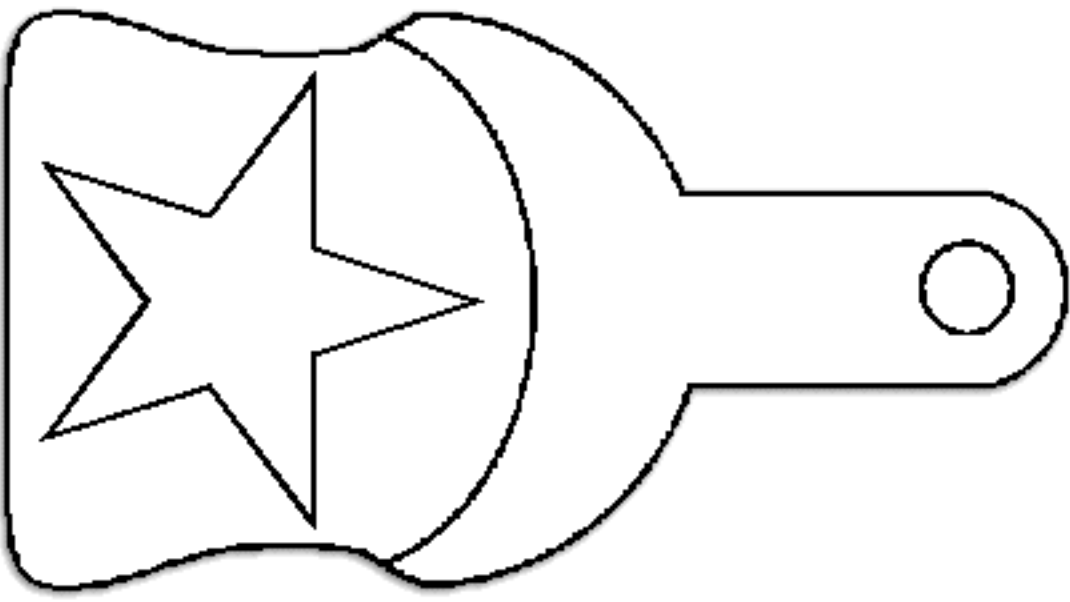
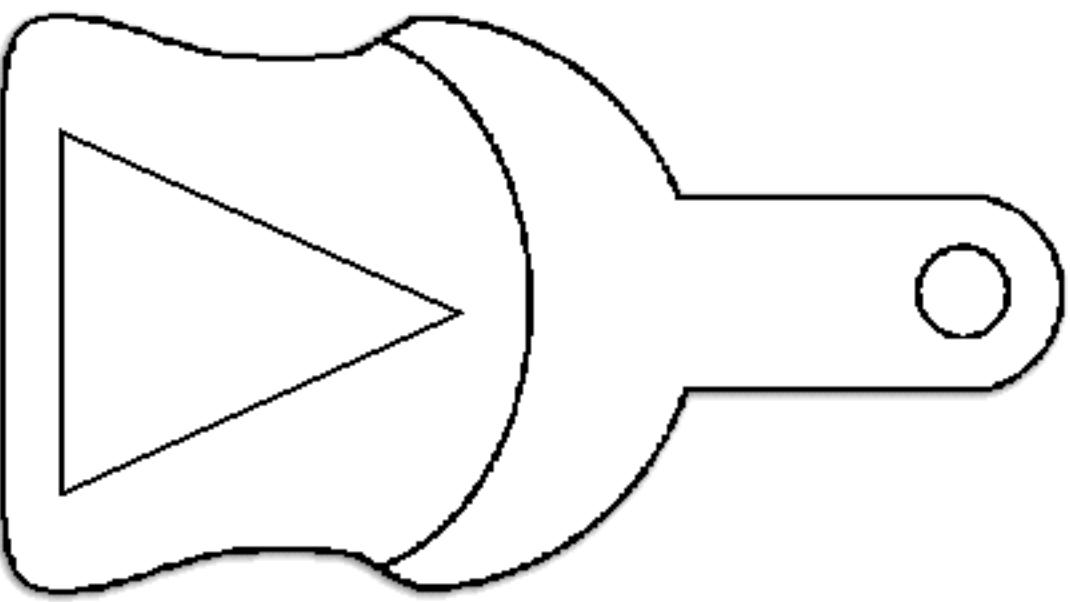
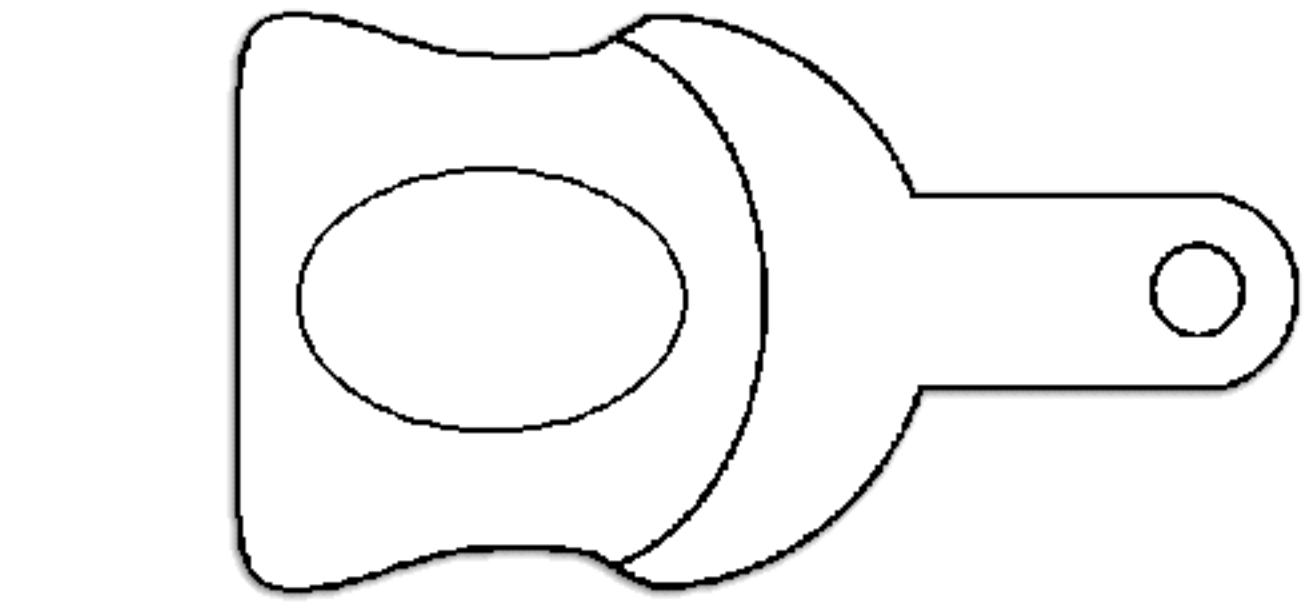

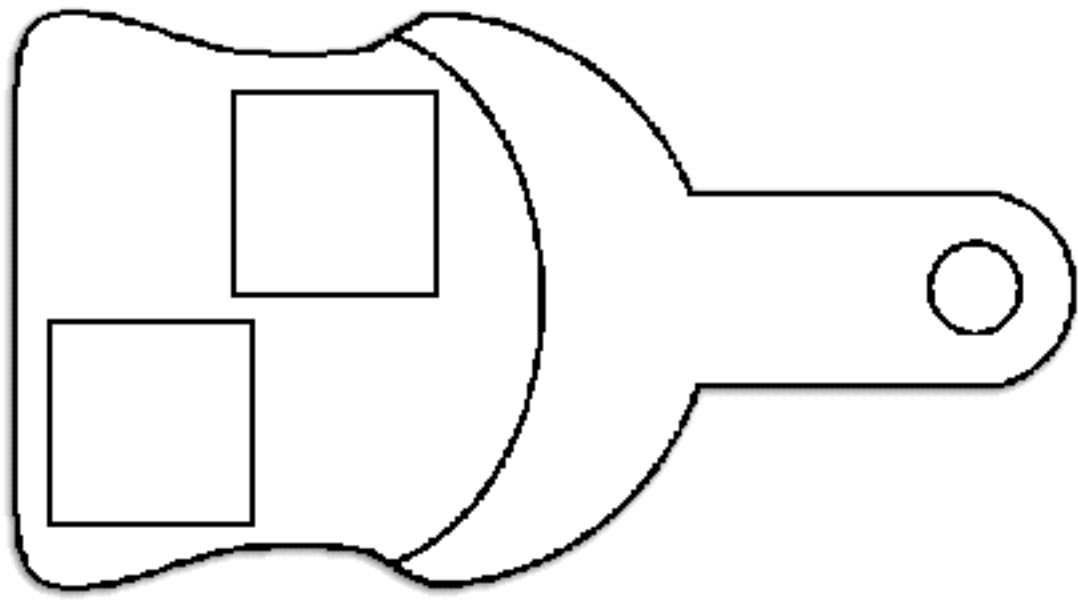
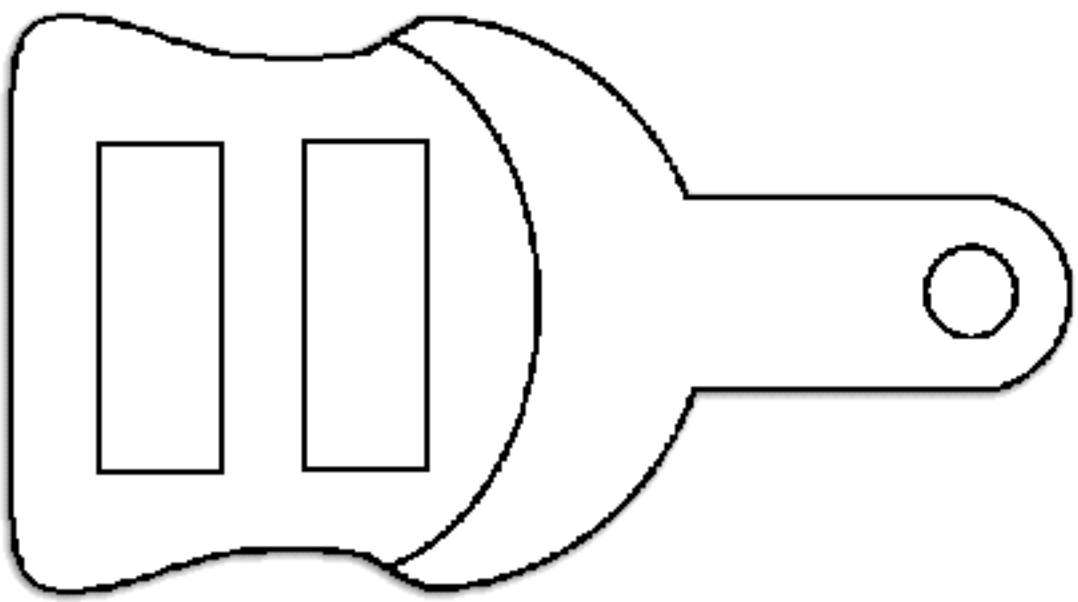
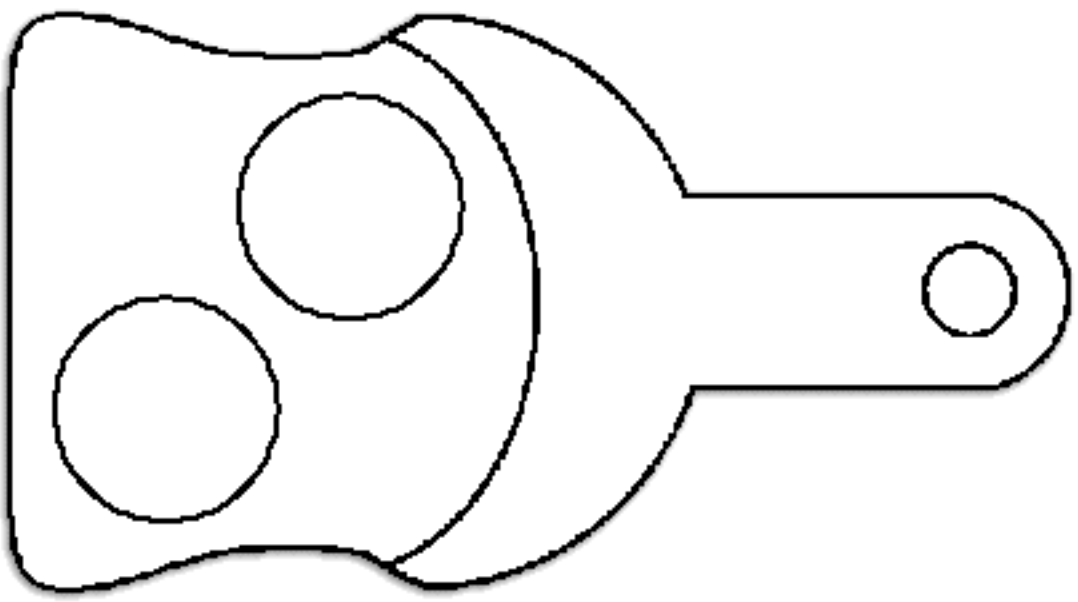

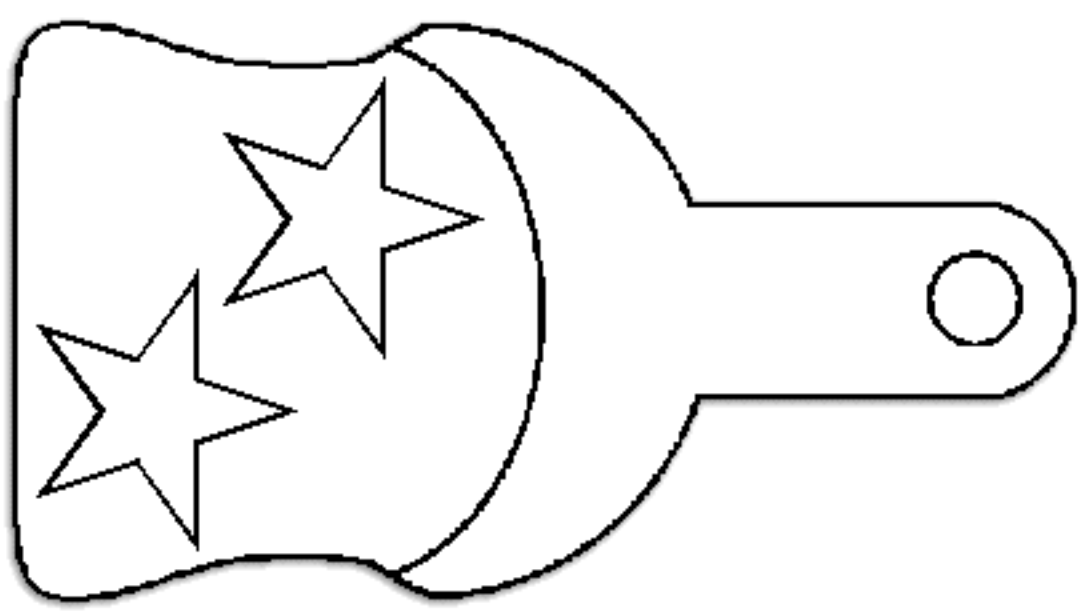
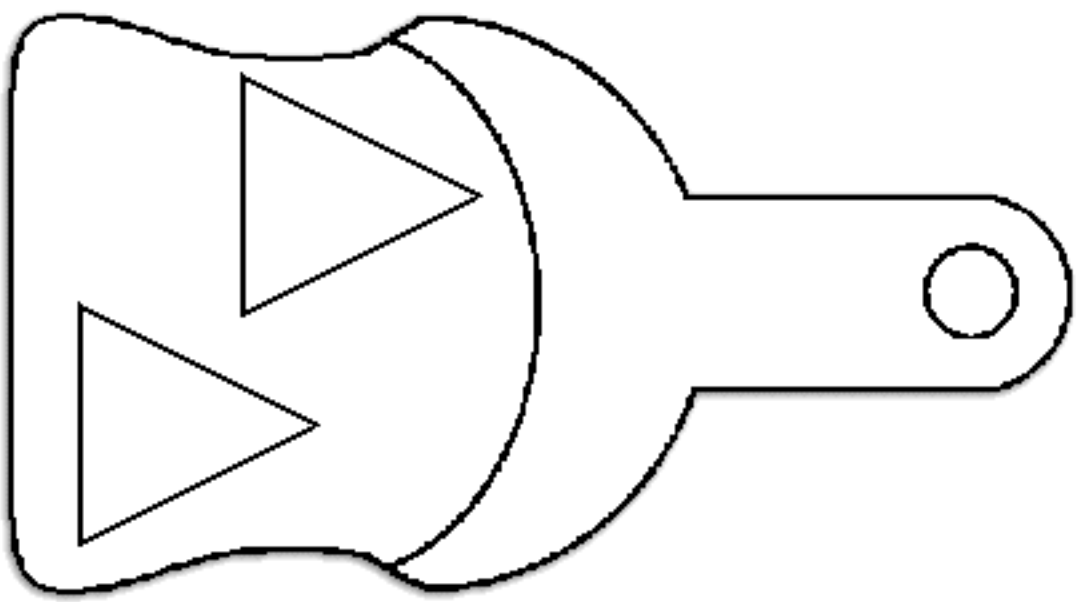
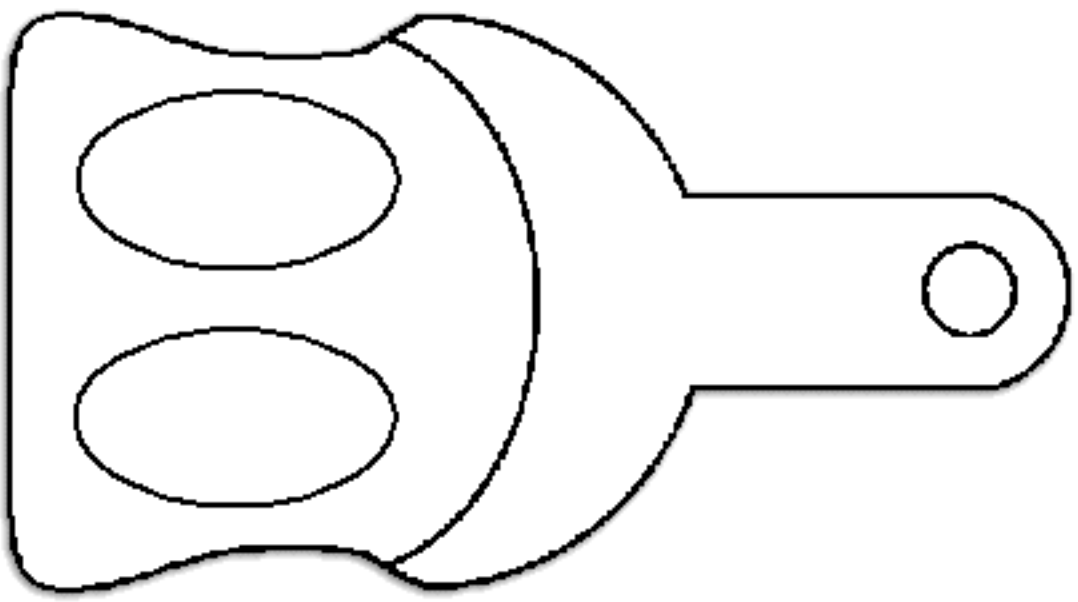

Paint Can and Paint Brush Shape Table/Floor Game

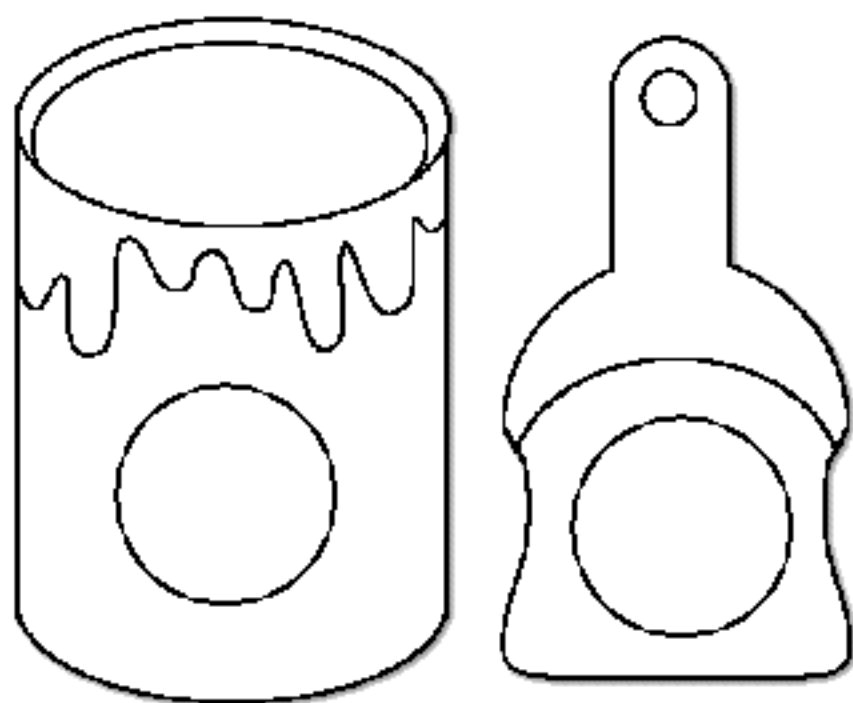

www.childcareland.com

Instructions: Print on cardstock paper ... cut out and laminate lay paint cans on the floor or table and place the correct matching paint brush on each can.

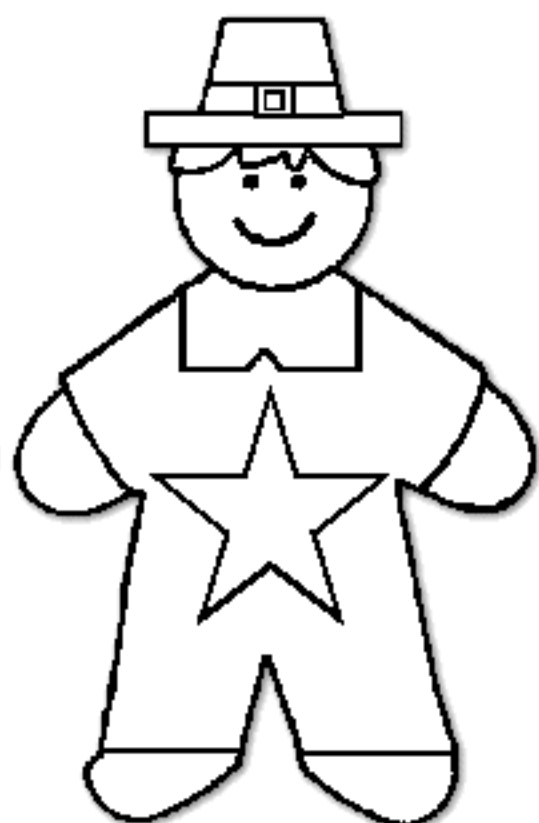
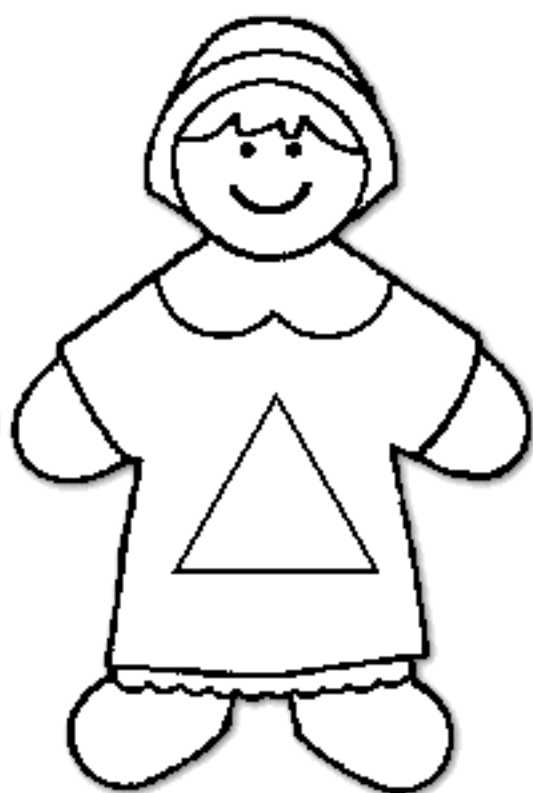
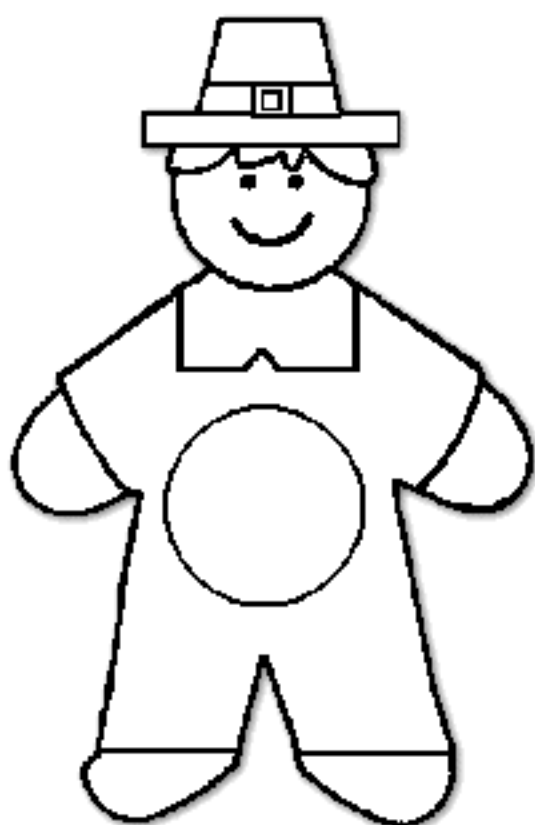
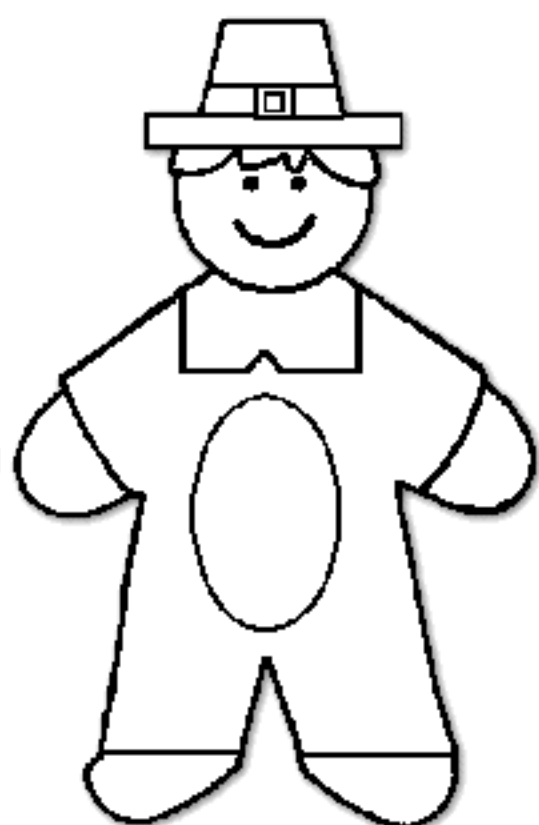
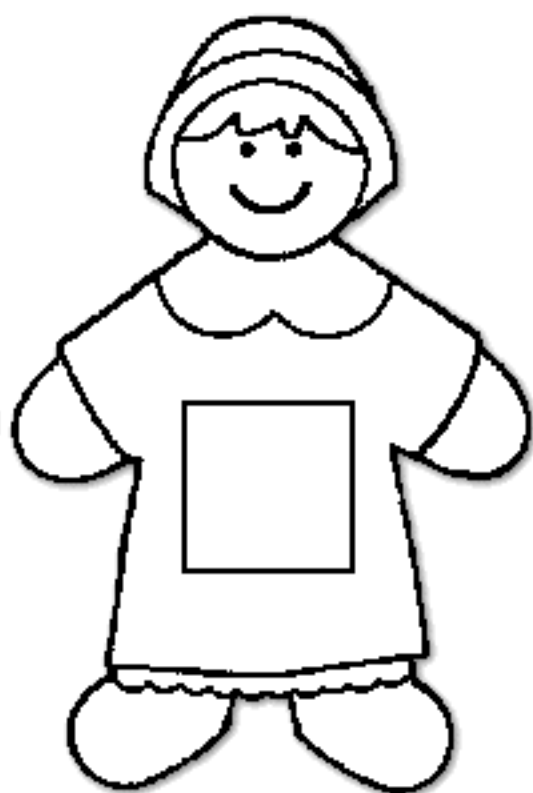
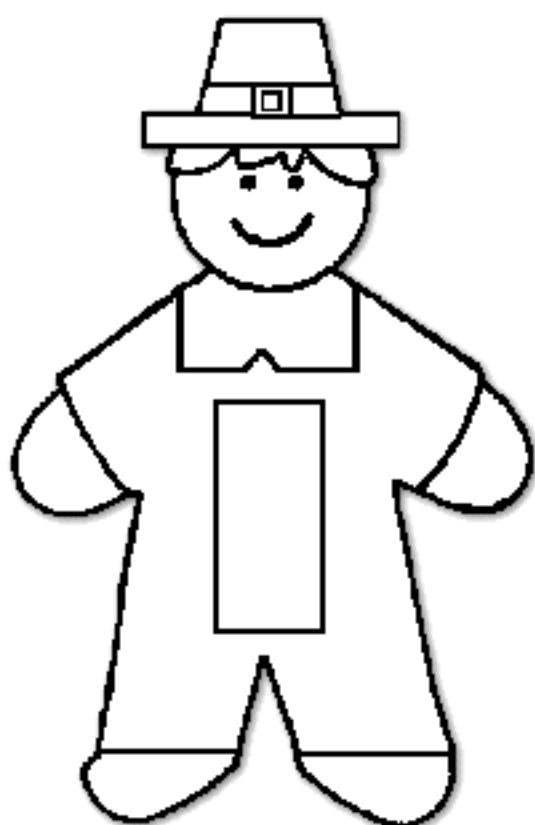

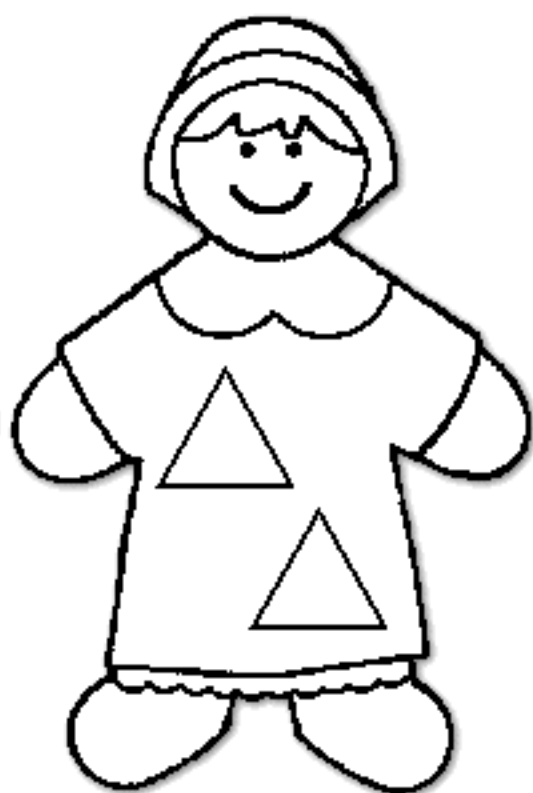
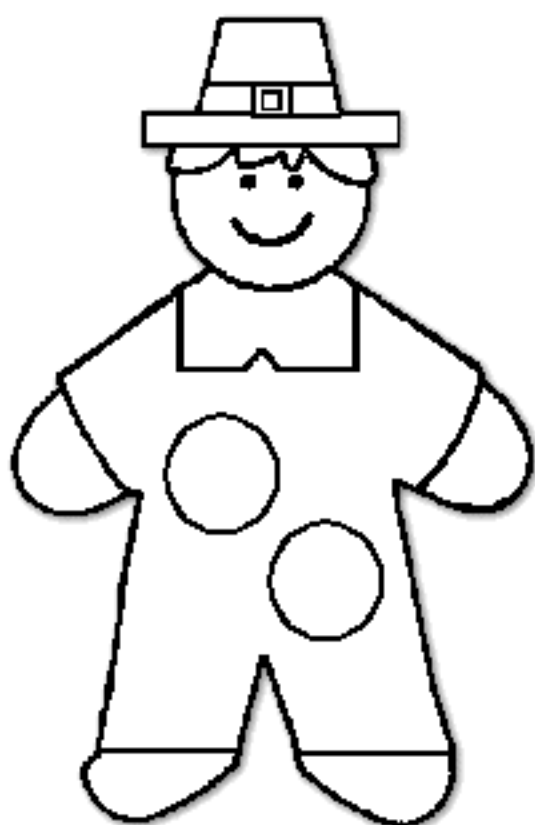
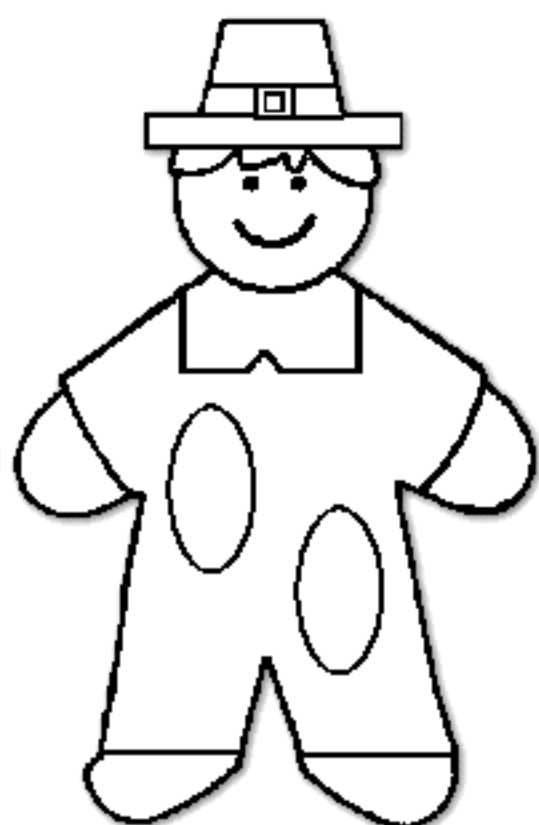
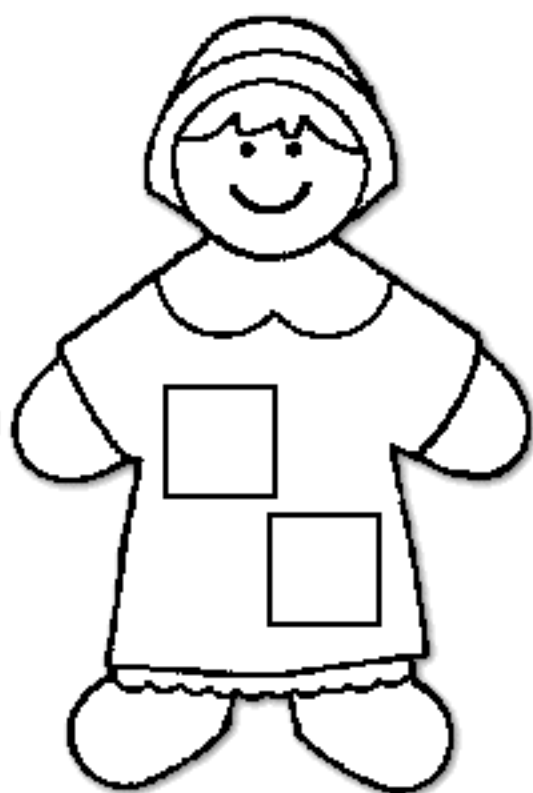
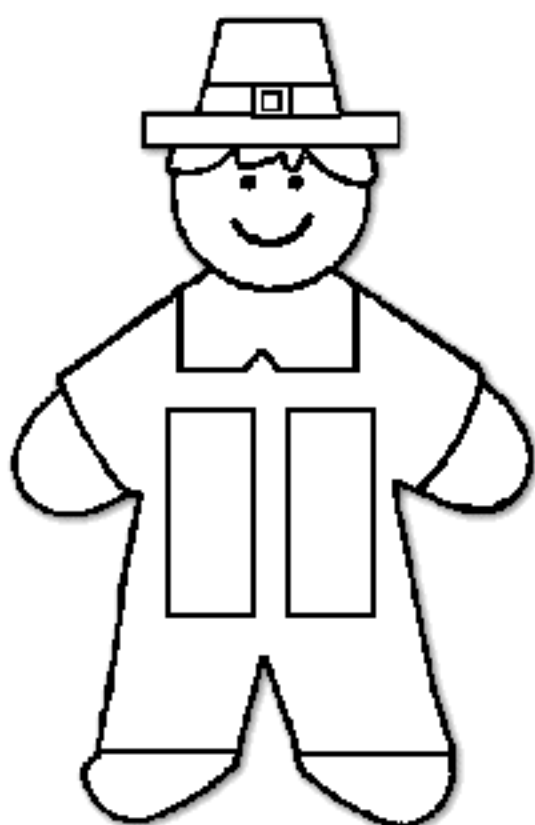

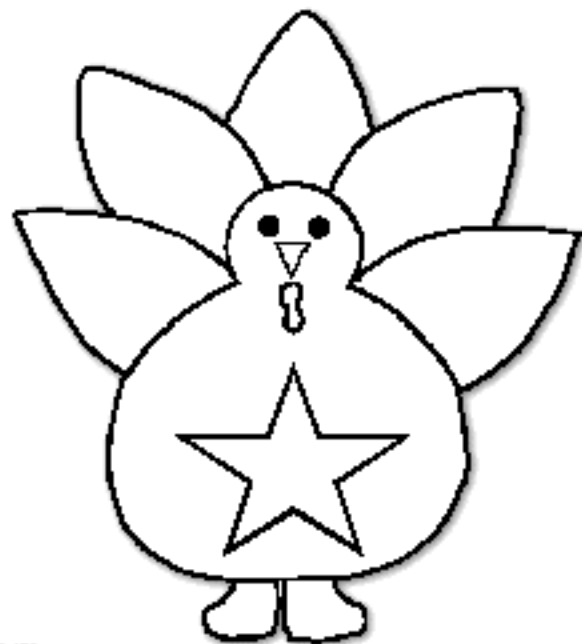
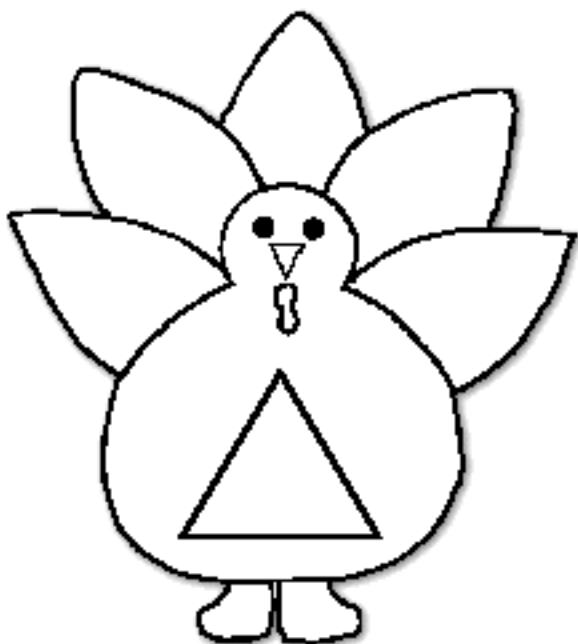
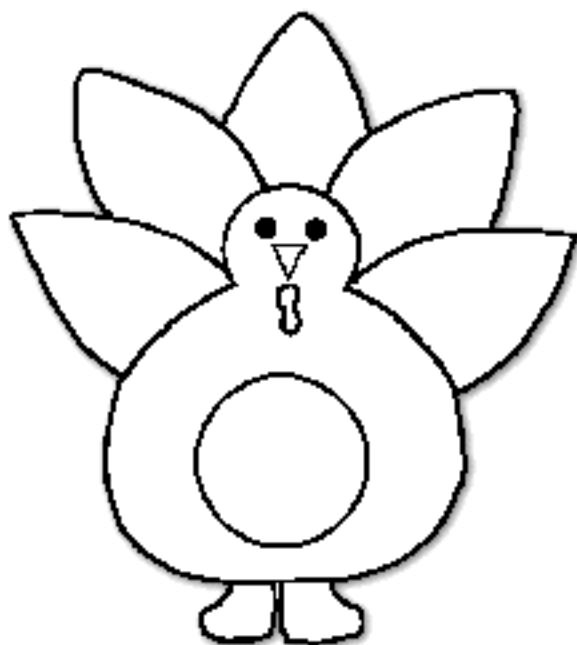
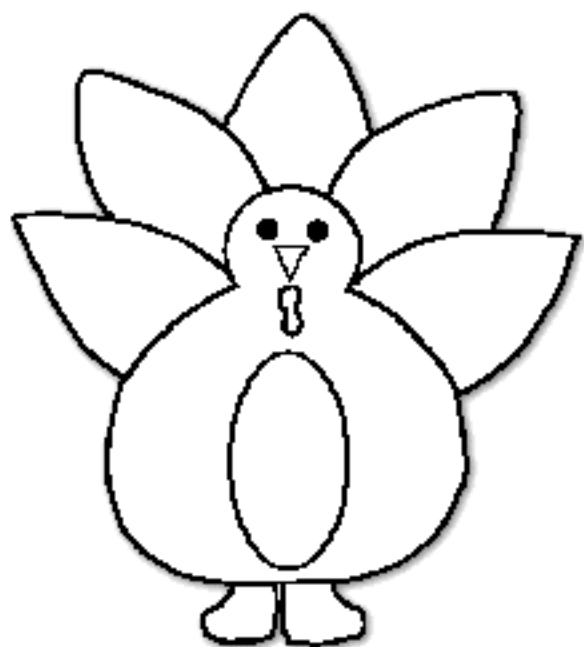
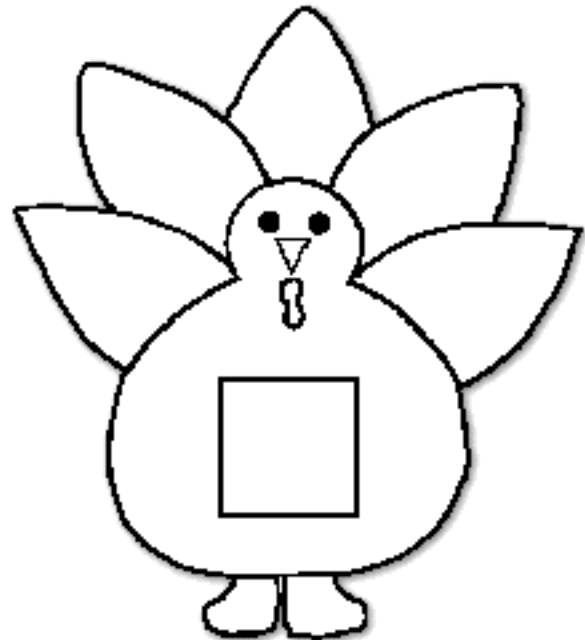
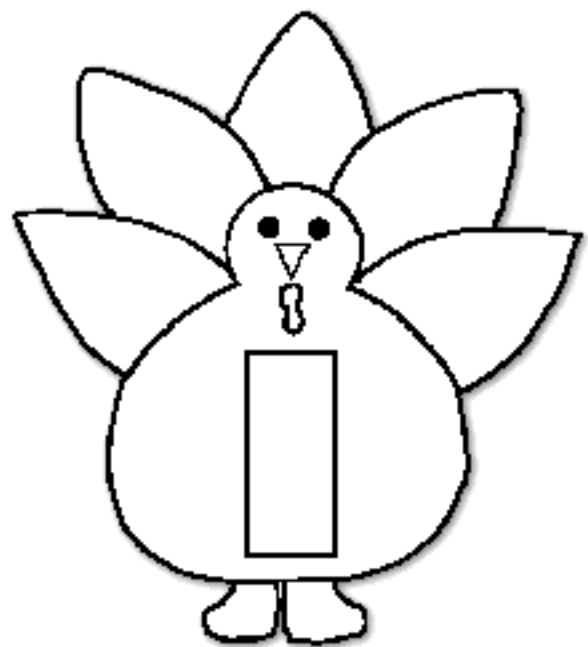

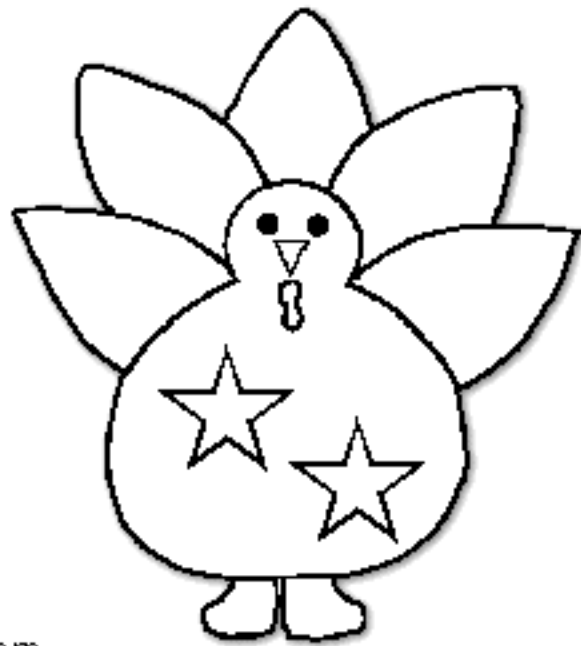
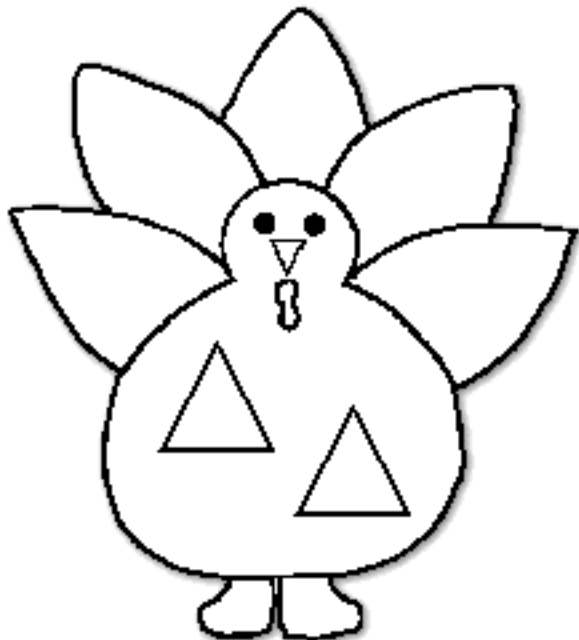
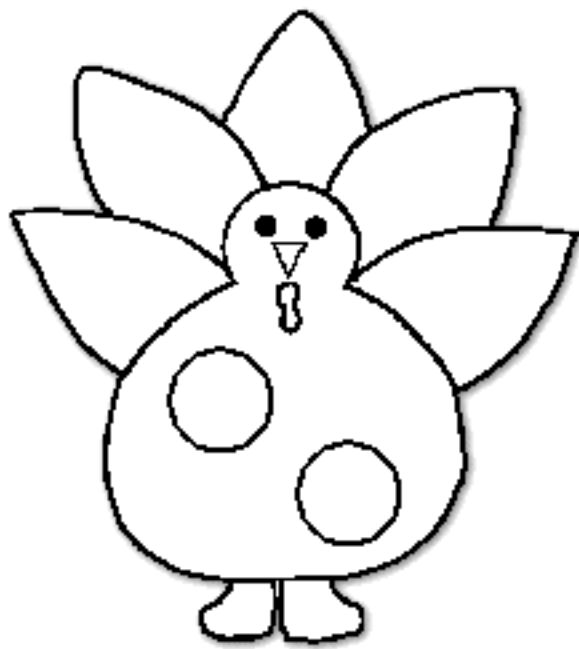
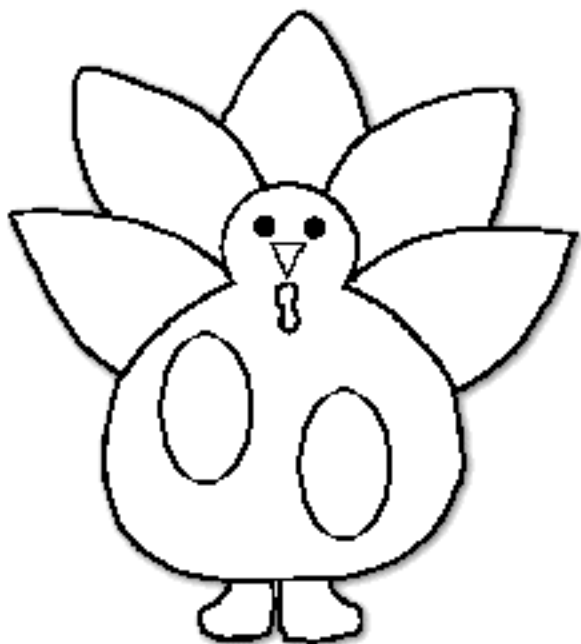
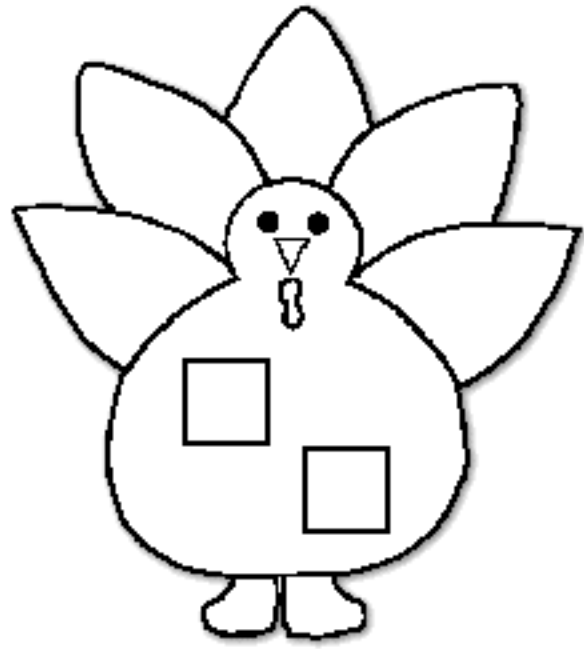
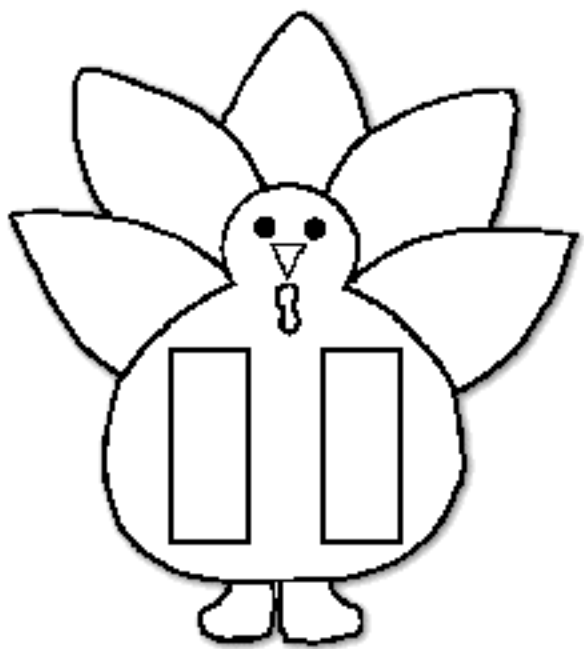

Pilgrim and Turkey Shape Match

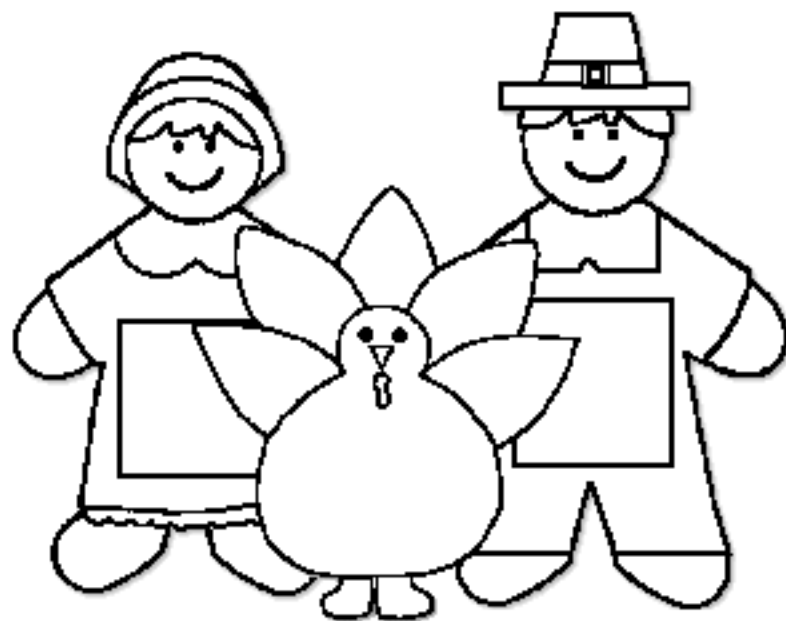

www.childcareland.com

Pilgrim and Turkey Shape Match

Instructions: Print Pilgrims on regular paper ... cut out and glue inside a file folder. Print turkeys on cardstock paper ... cut out and laminate. Children match the turkeys to the Pilgrims with the same shapes. Store loose pieces in a zip lock bag.

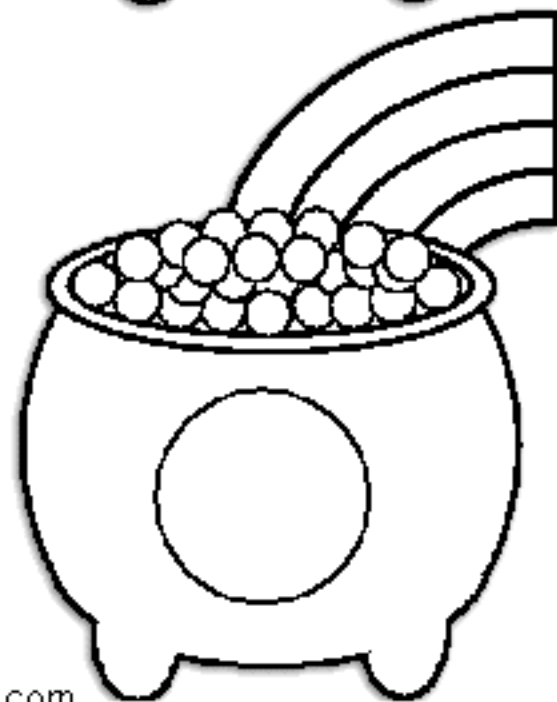
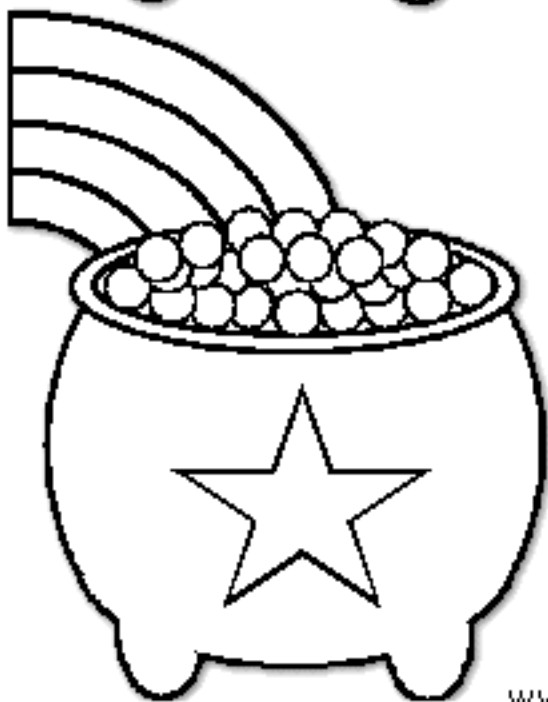
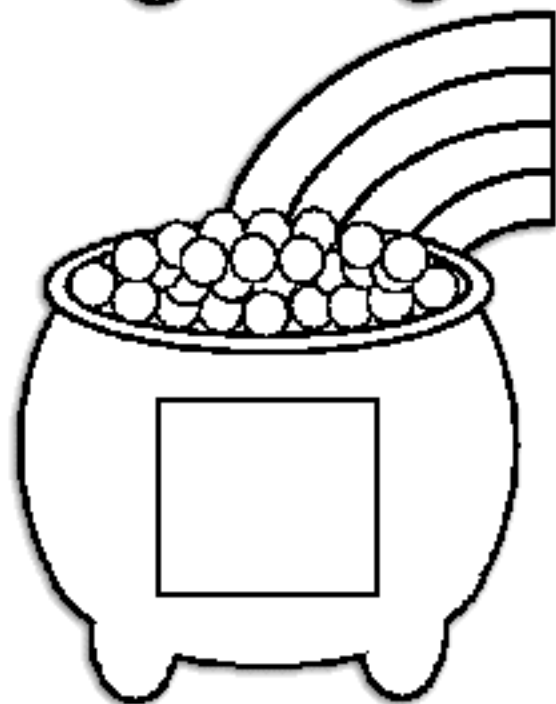
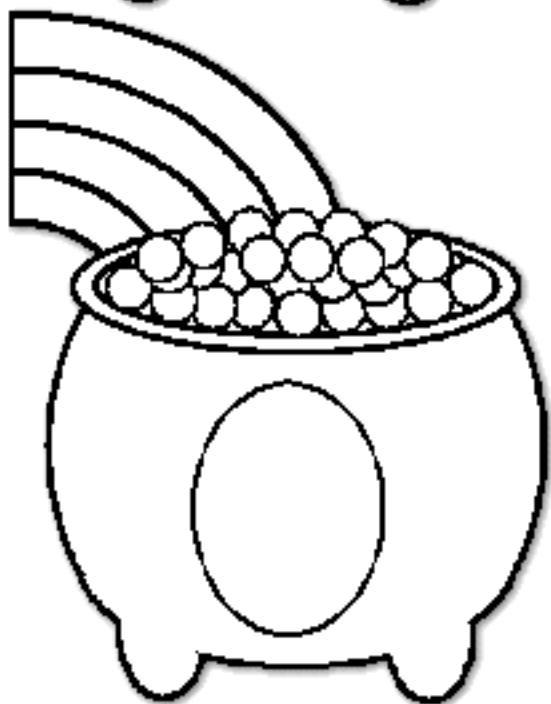
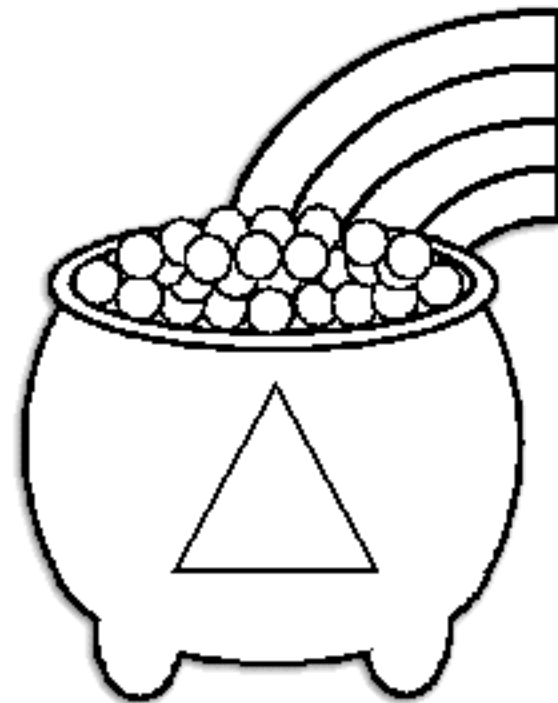
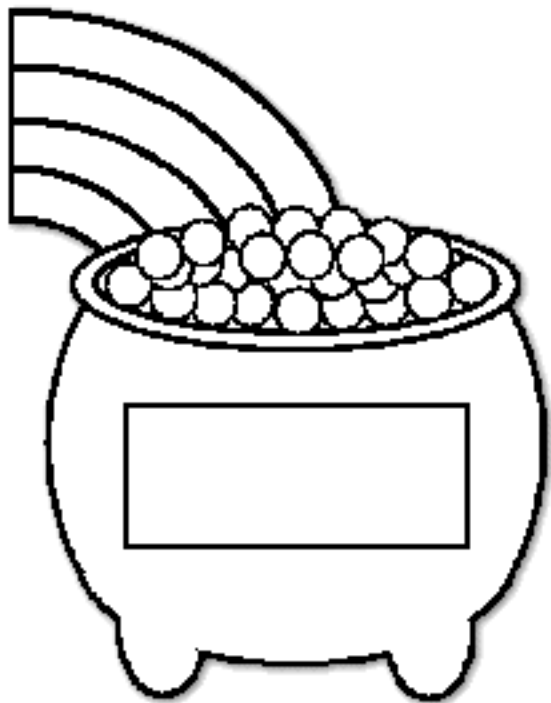

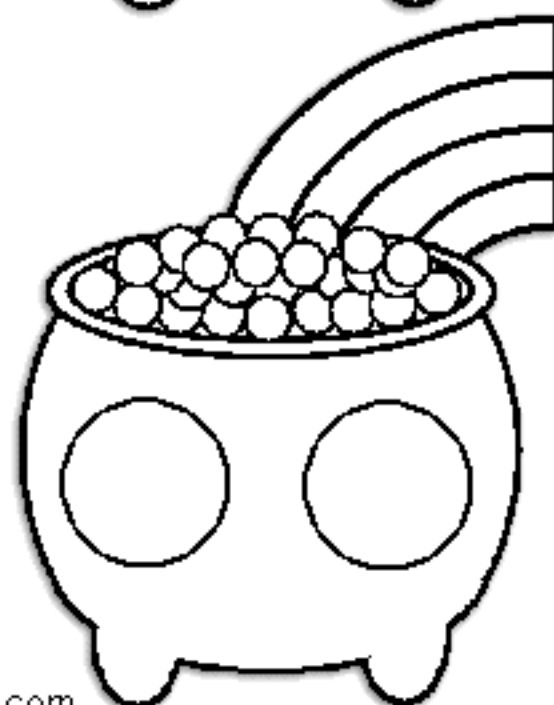
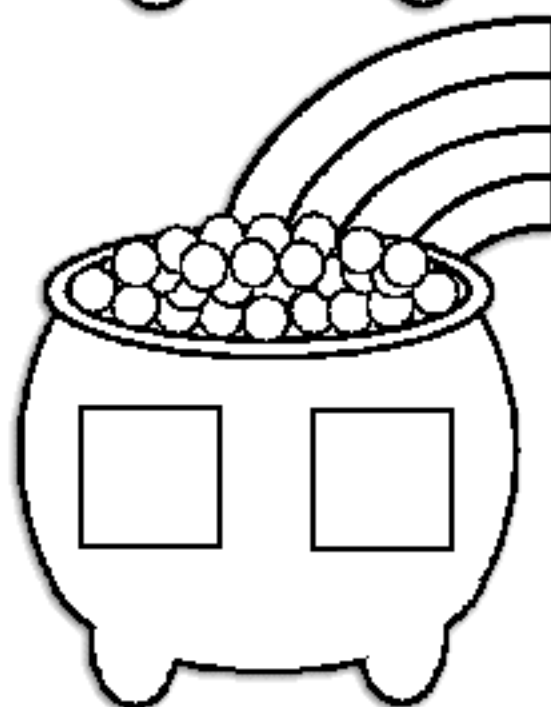
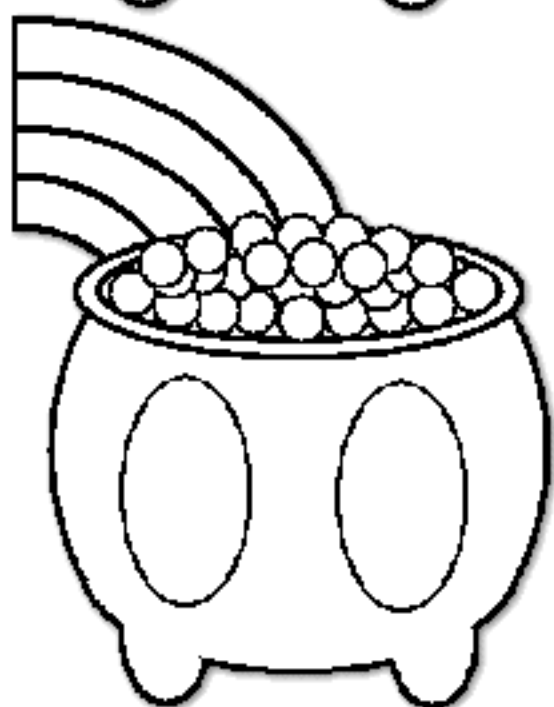
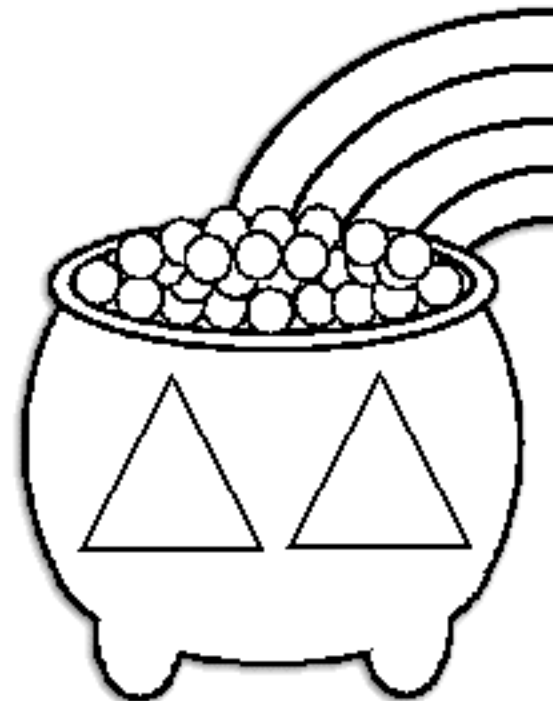
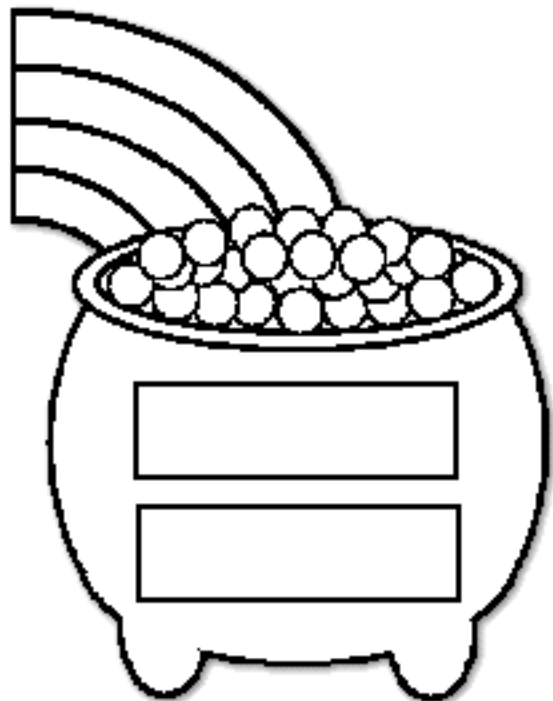

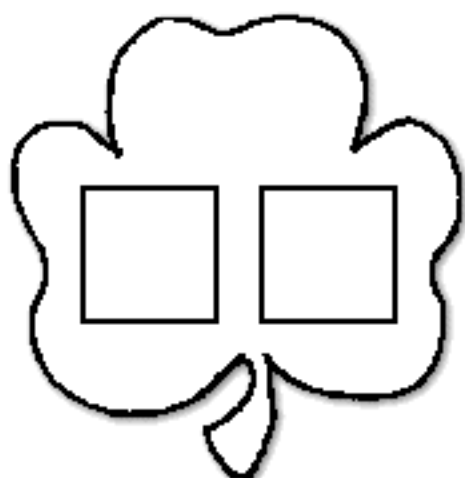
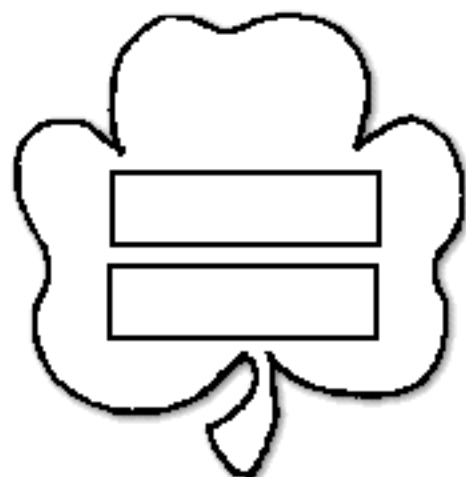
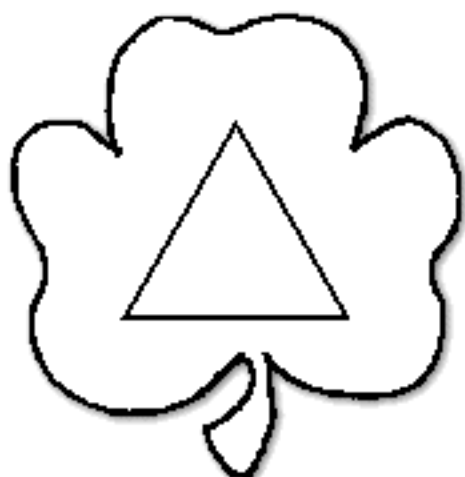
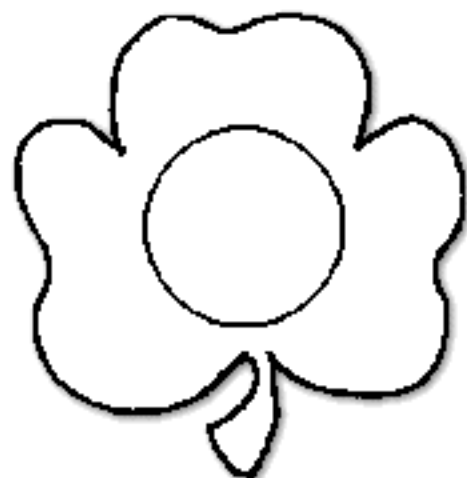
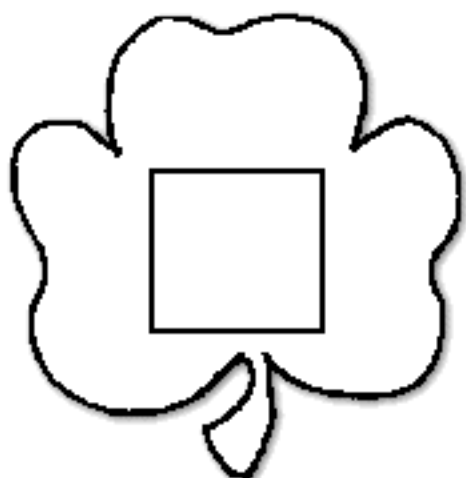
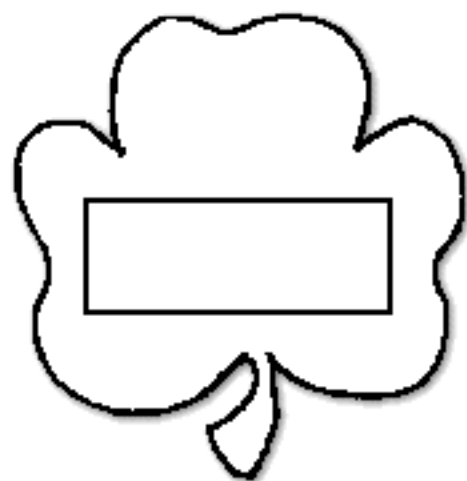

Pot-O-Gold and Shamrock Shape Match

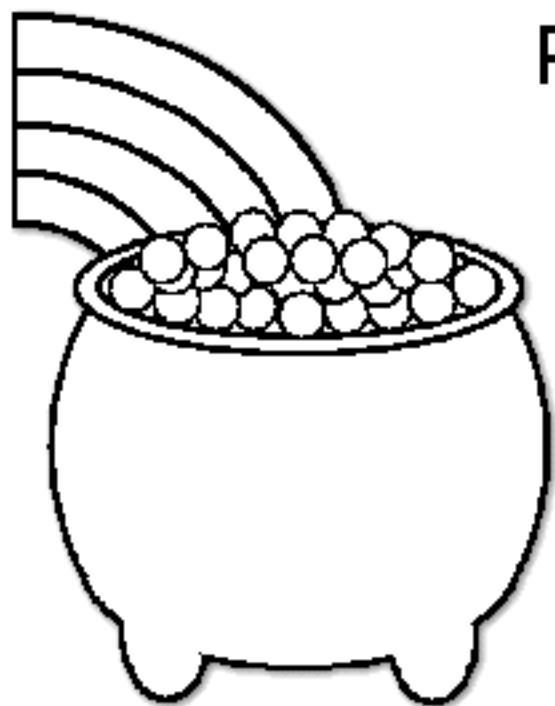

www.childcareland.com

Pot-O-Gold and Shamrock
Shape Match

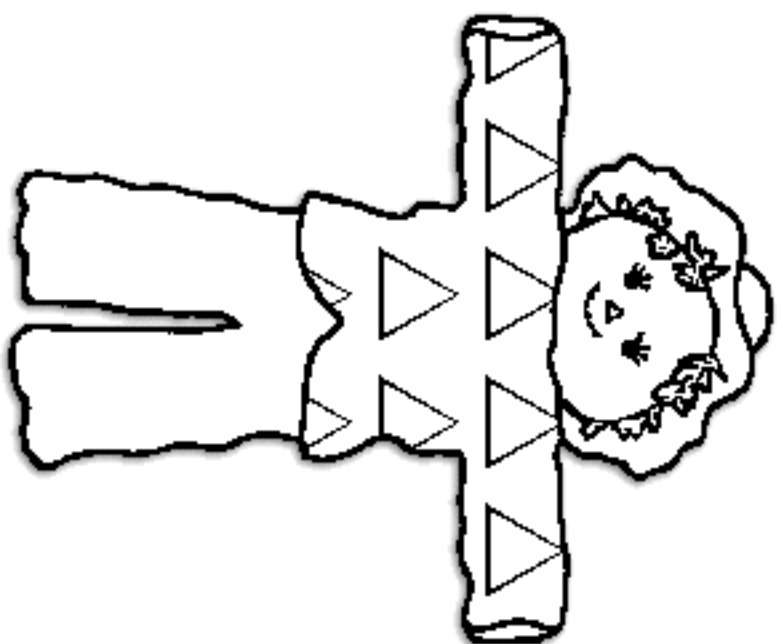
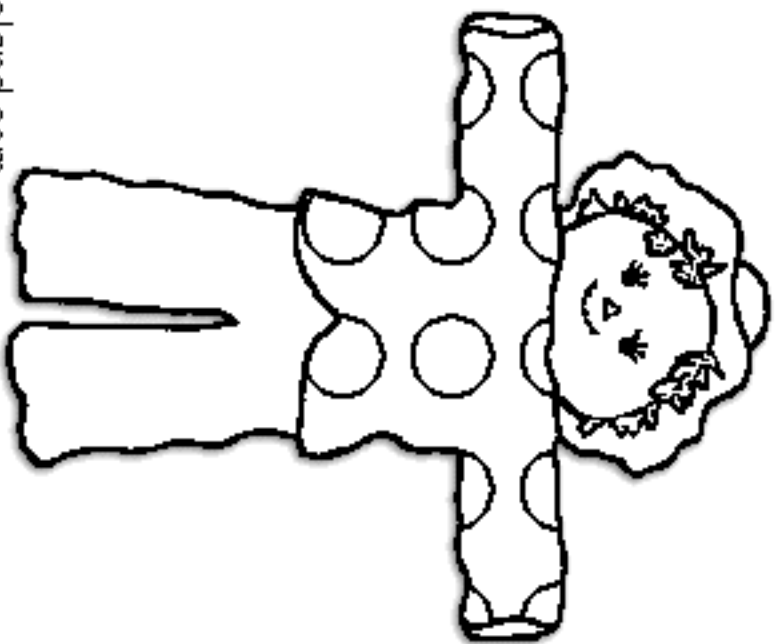
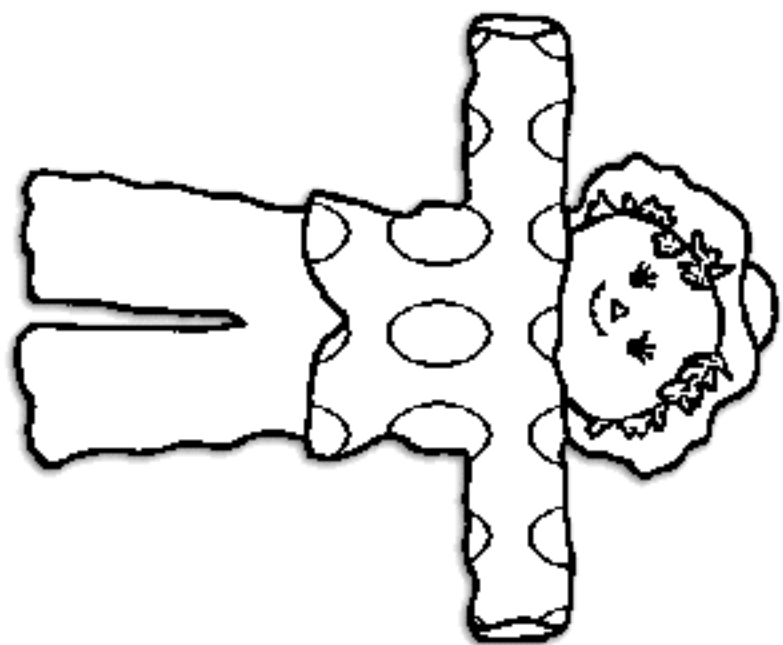
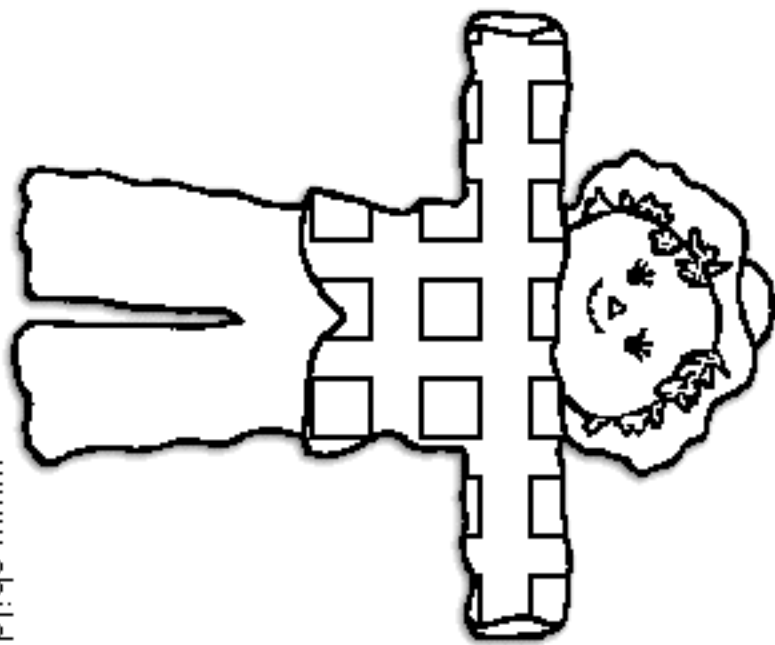
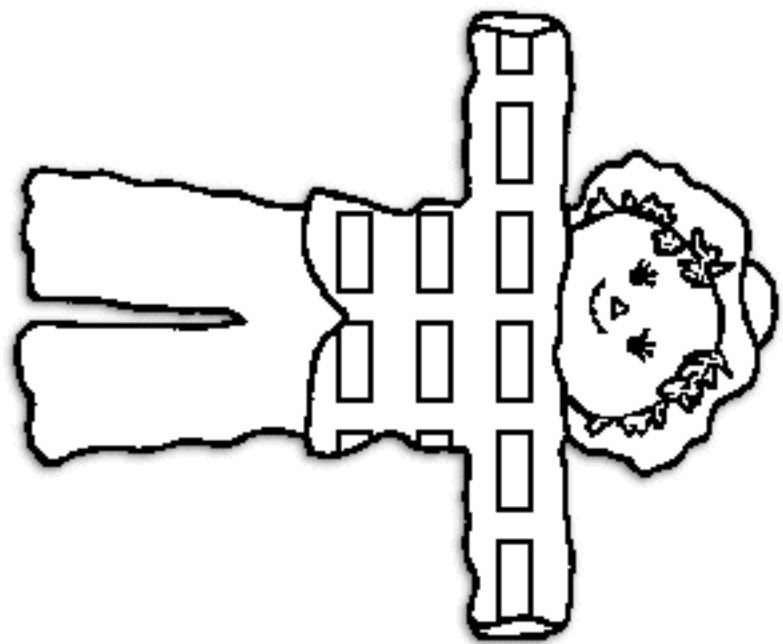
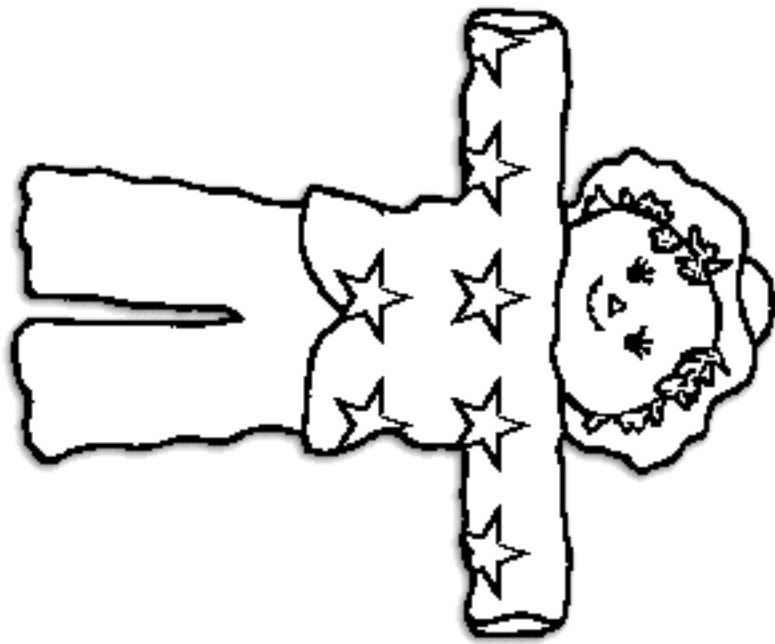

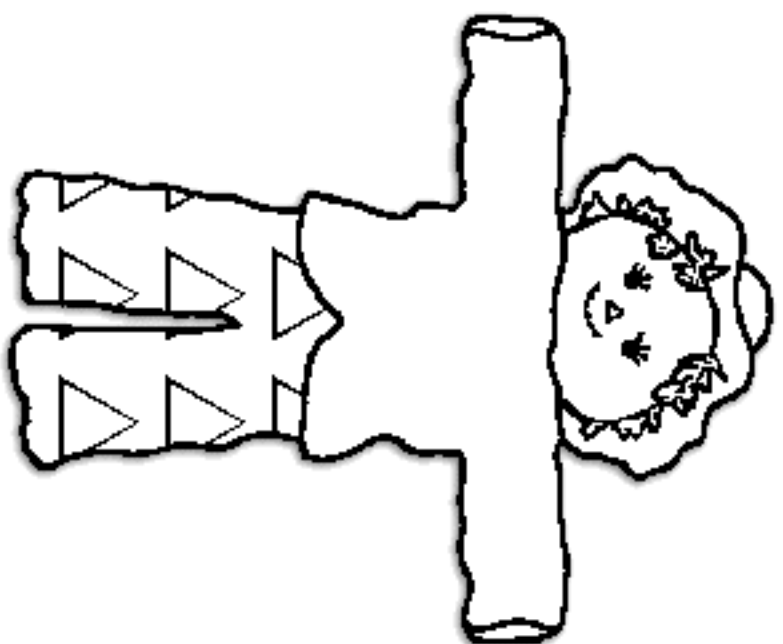
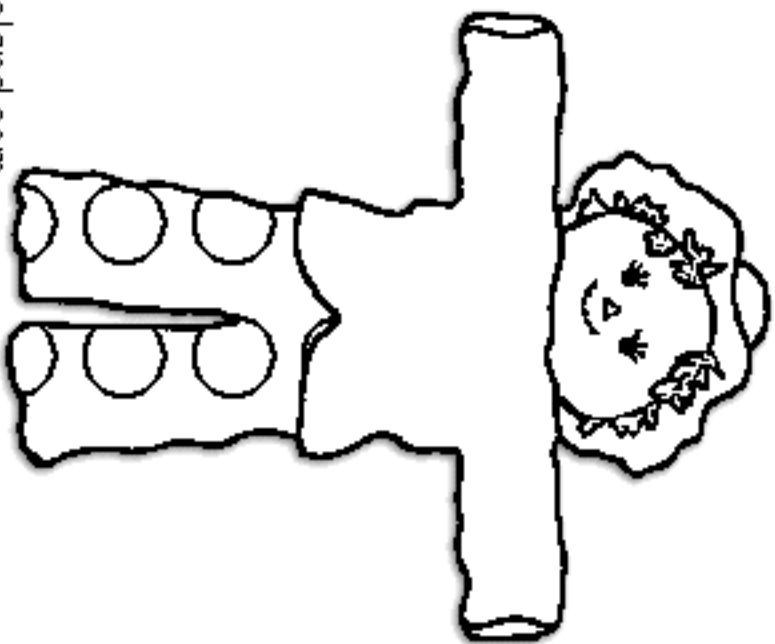
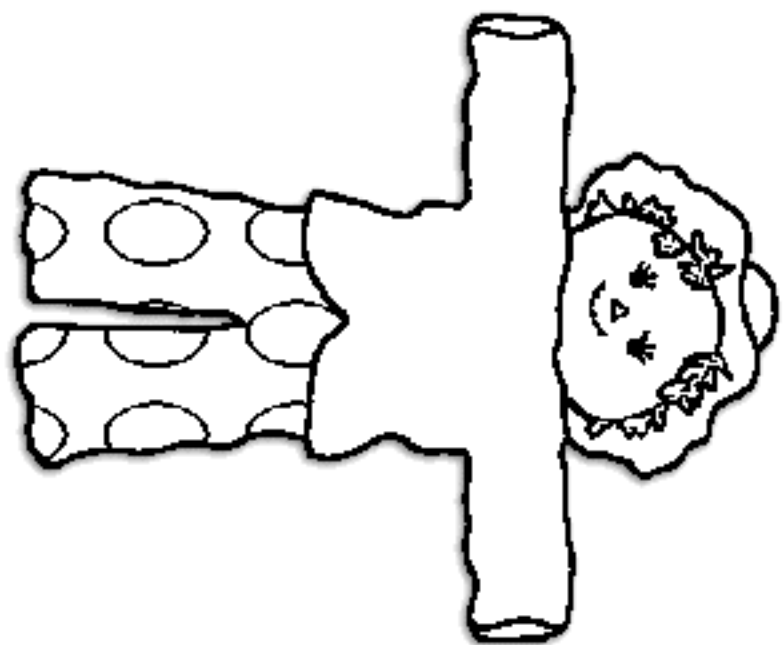
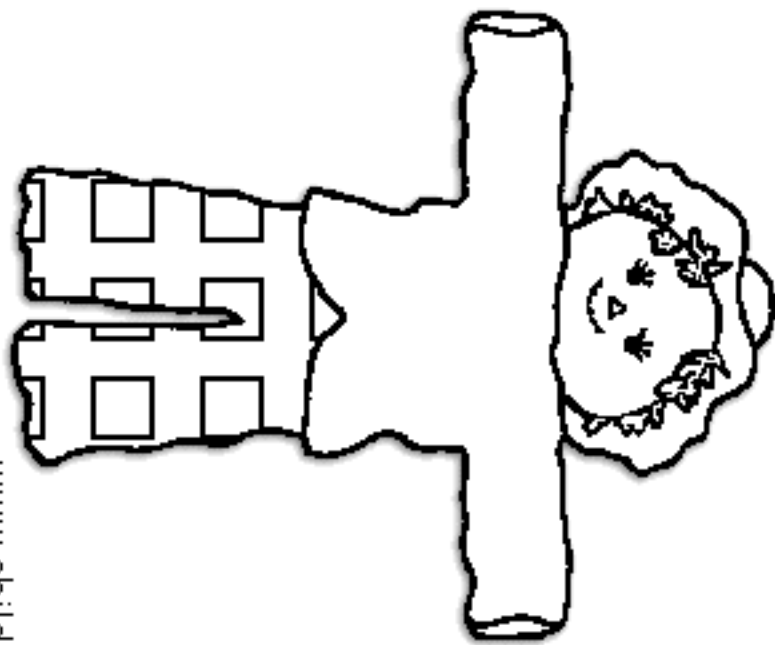
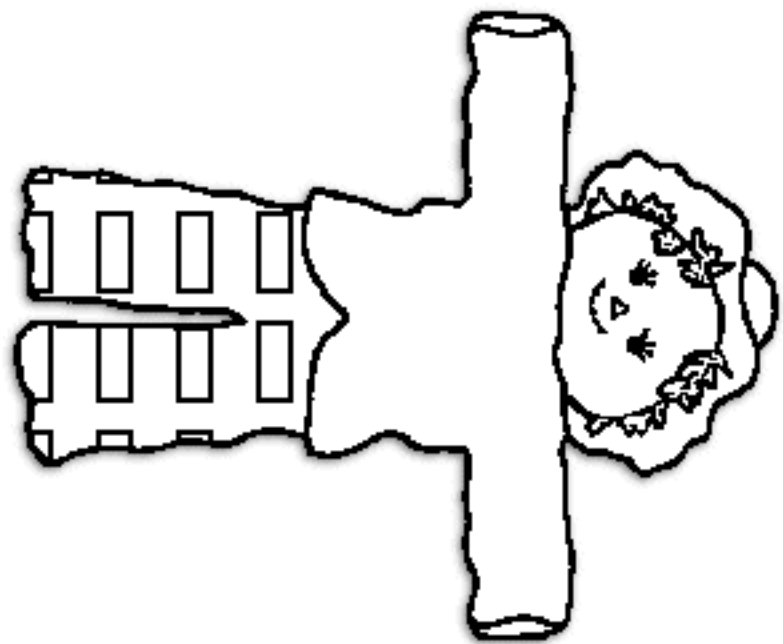
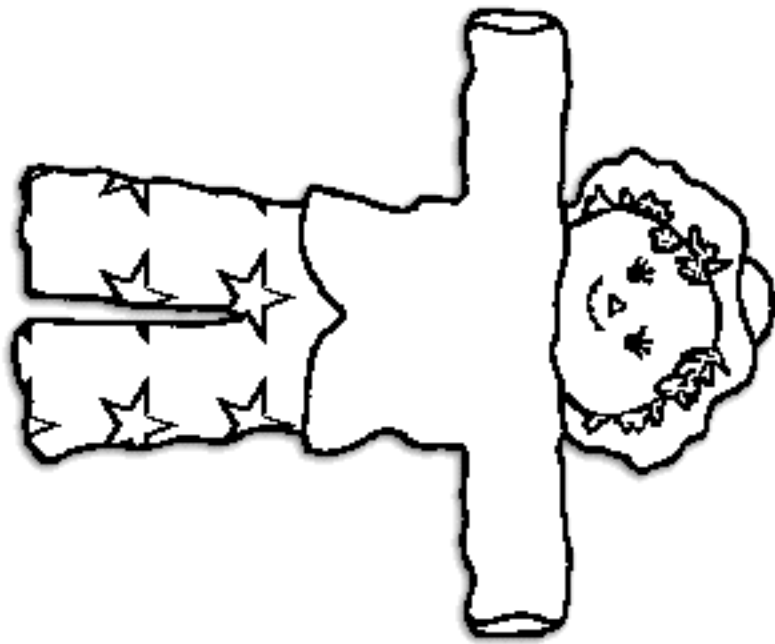

Scarecrow Shape Match

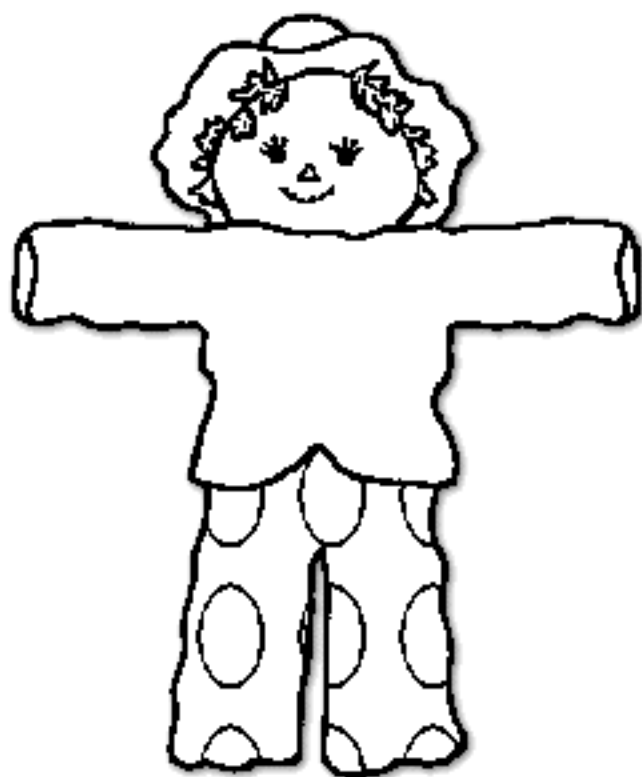

www.childcareland.com

Scarecrow Shape Match

Instructions: Print two copies (one on cardstock paper and one on regular paper). Cut out and glue the paper scarecrows inside a file folder. Cut out and laminate the cardstock scarecrows. Children match the loose scarecrow pieces to those inside the file folder. Store the loose pieces in a zip lock bag or envelope.

Shamrock Shape Match Book

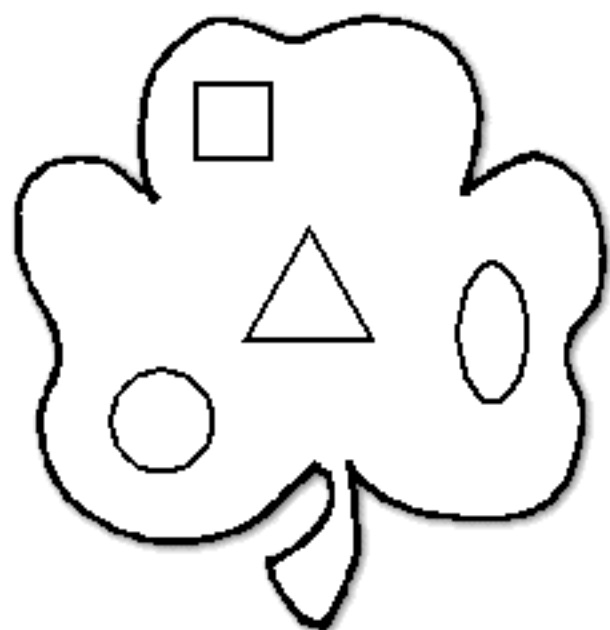

www.childcareland.com

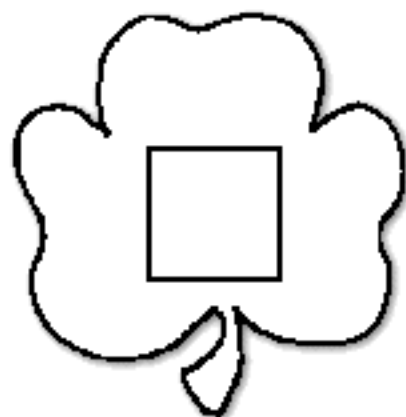

www.childcareland.com



www.childcareland.com



www.childcareland.com

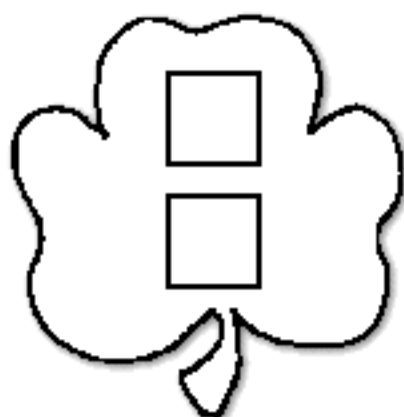

www.childcareland.com



www.childcareland.com



www.childcareland.com

Instructions: Print book and assemble. Children cut shamrock shape squares out and glue on the blank square next to the matching shamrock shape.

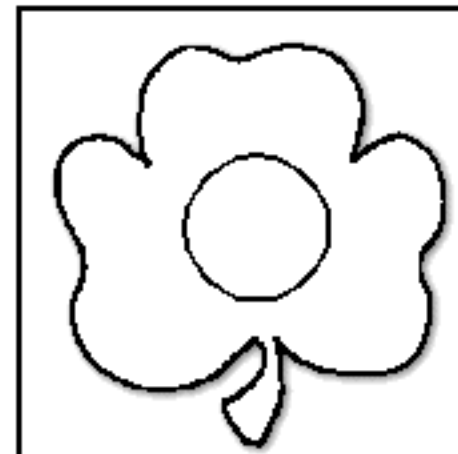
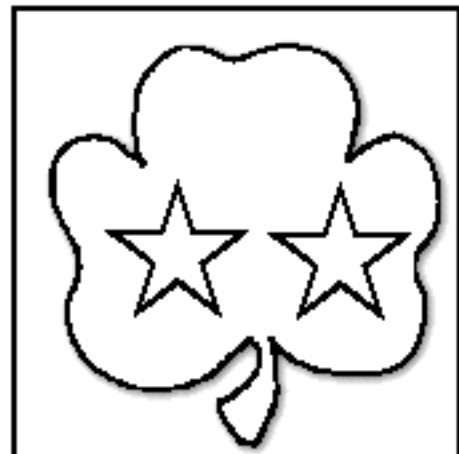
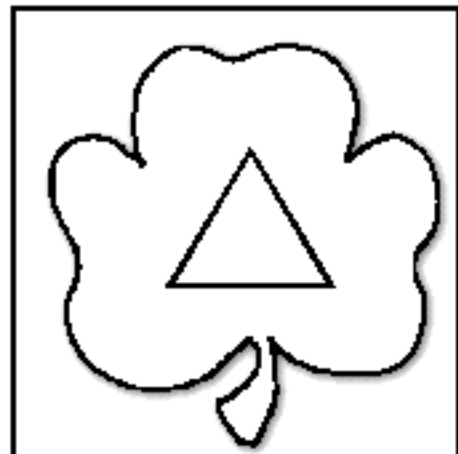
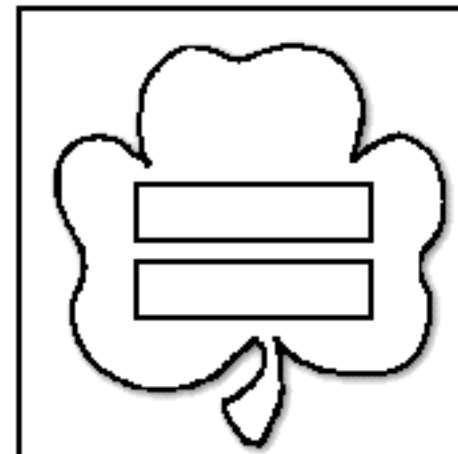
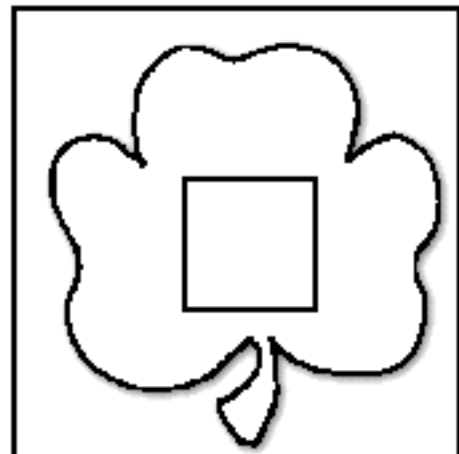
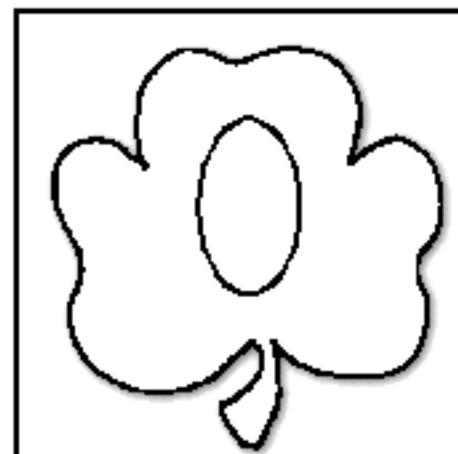
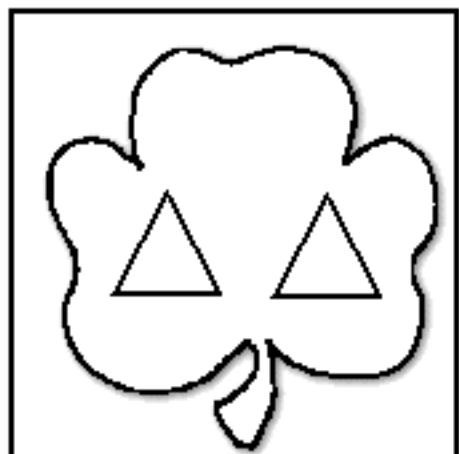
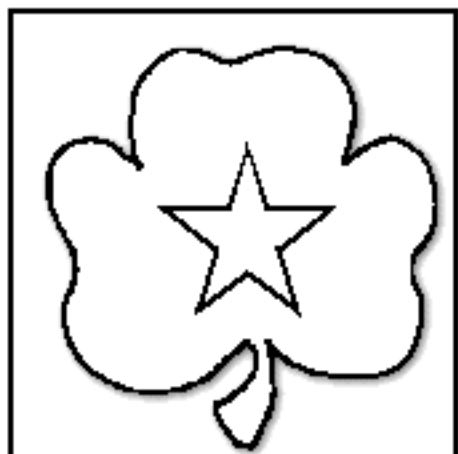
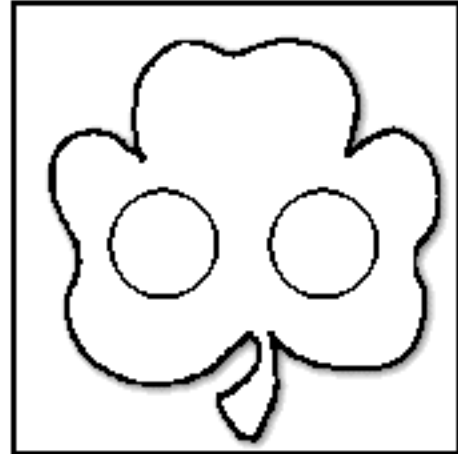
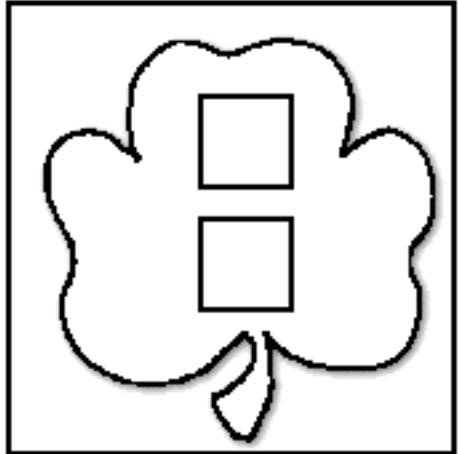
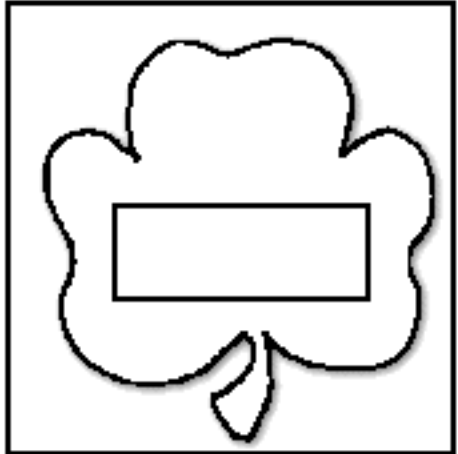

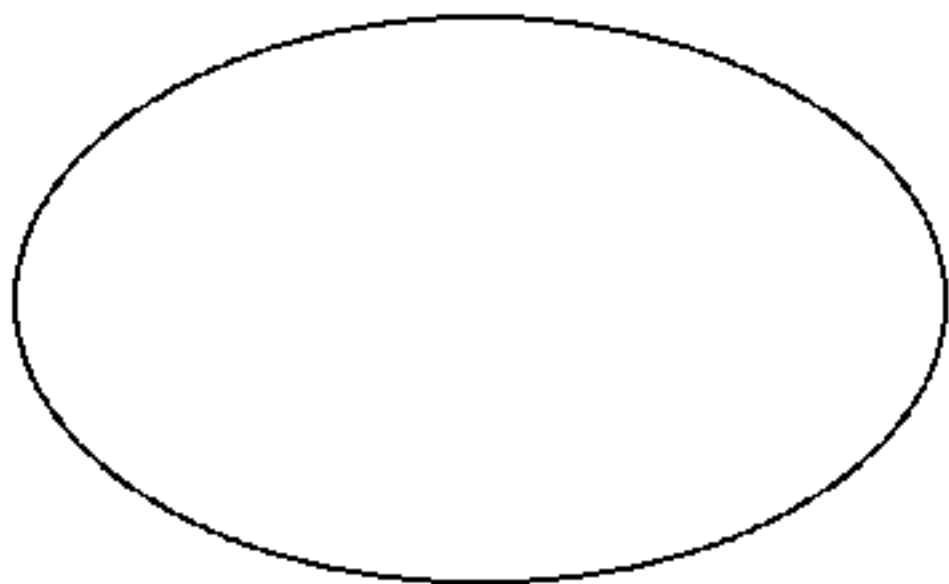
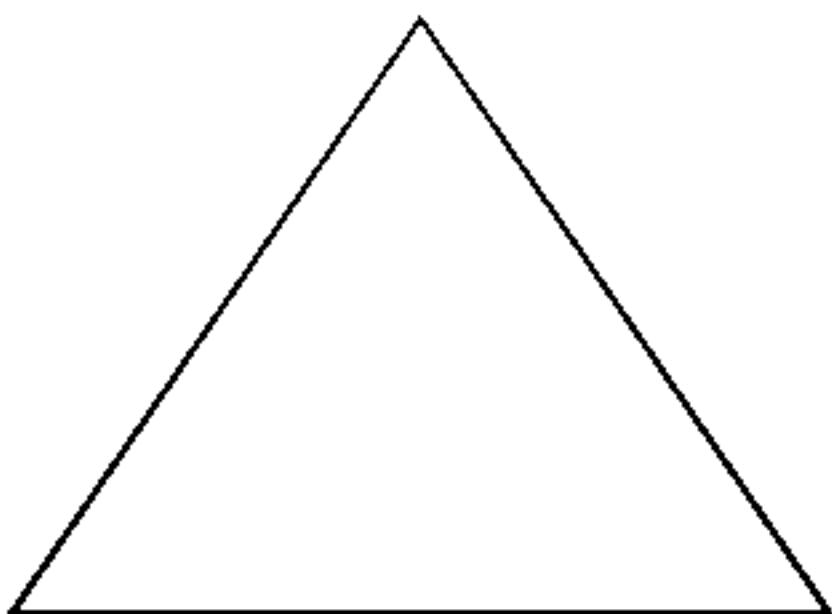
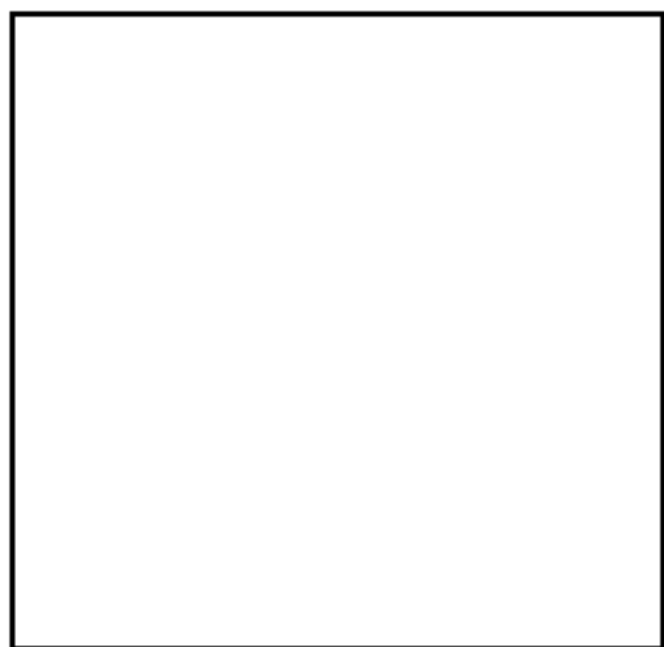

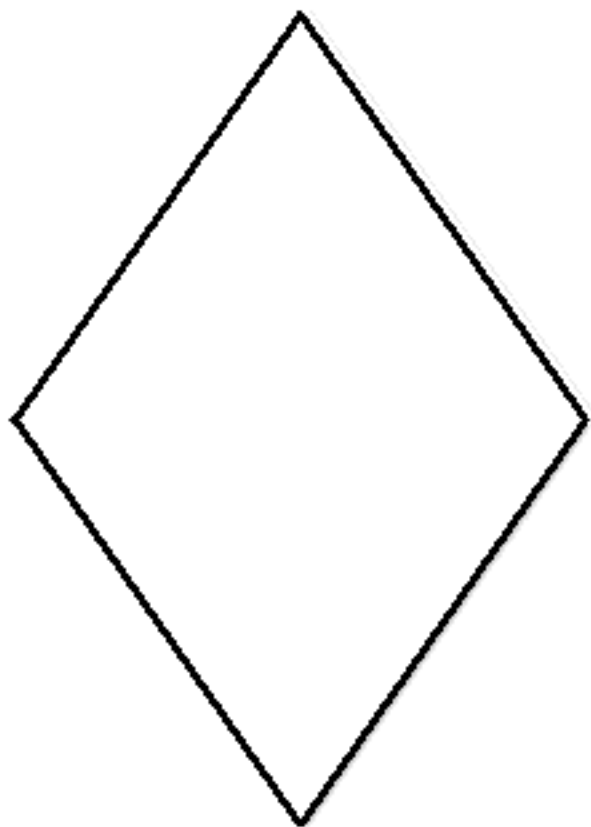
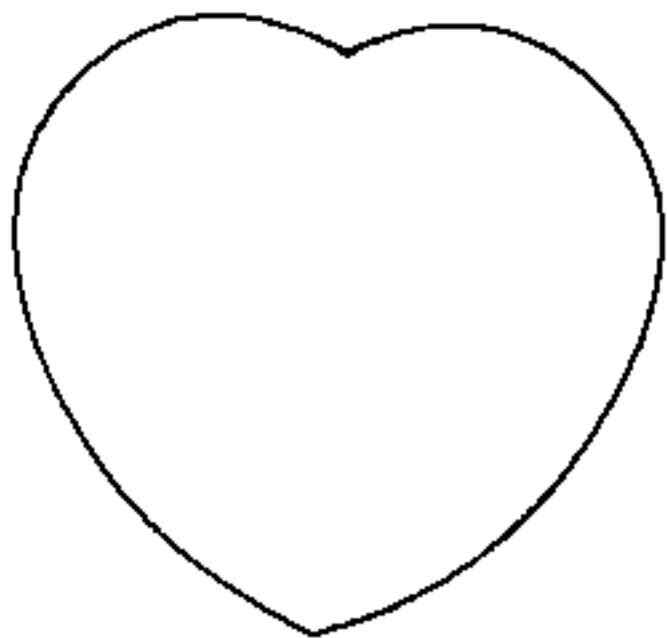
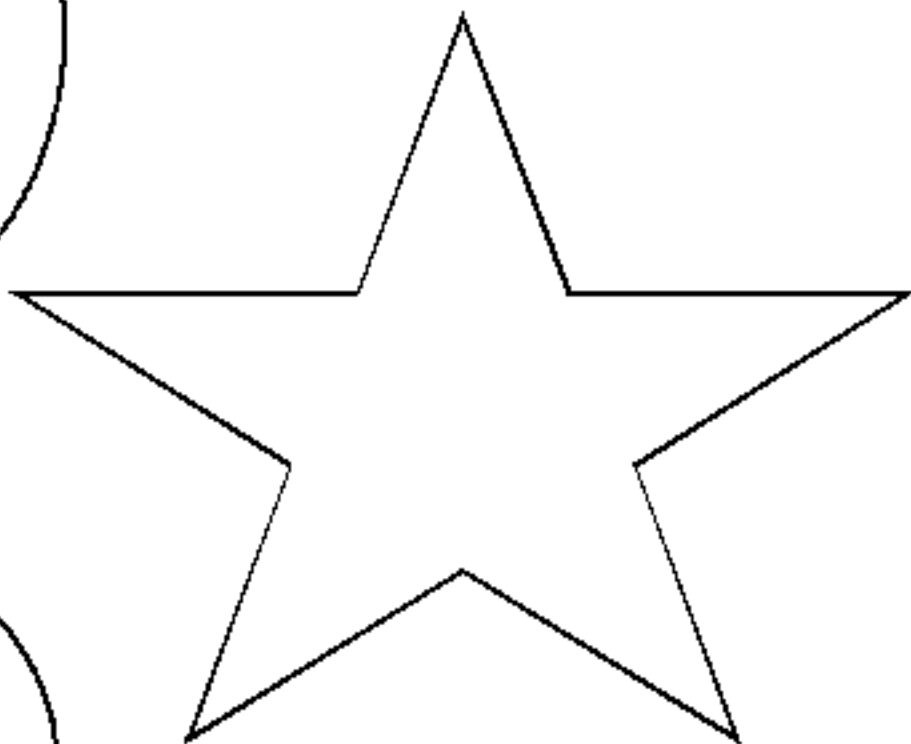
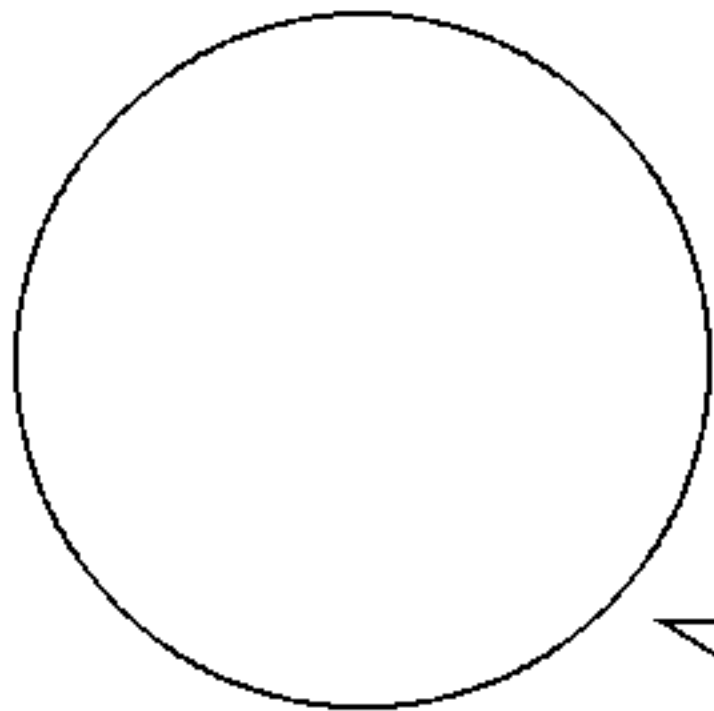

How many stars did you find?

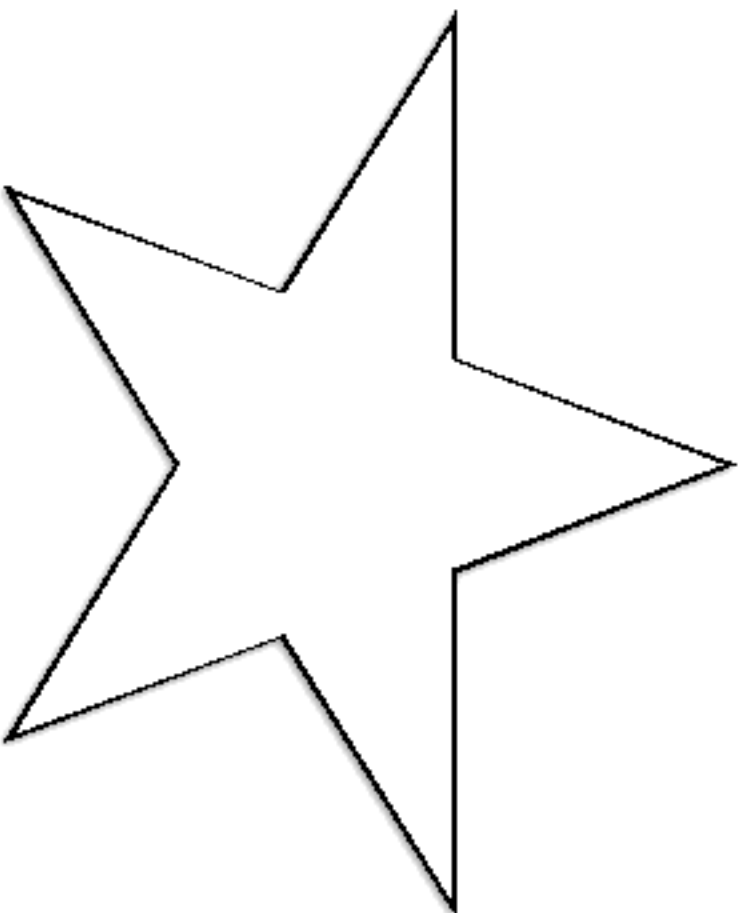

--	--	--	--	--	--	--	--	--	--	--	--	--	--	--	--	--	--	--	--

How many circles did you find?

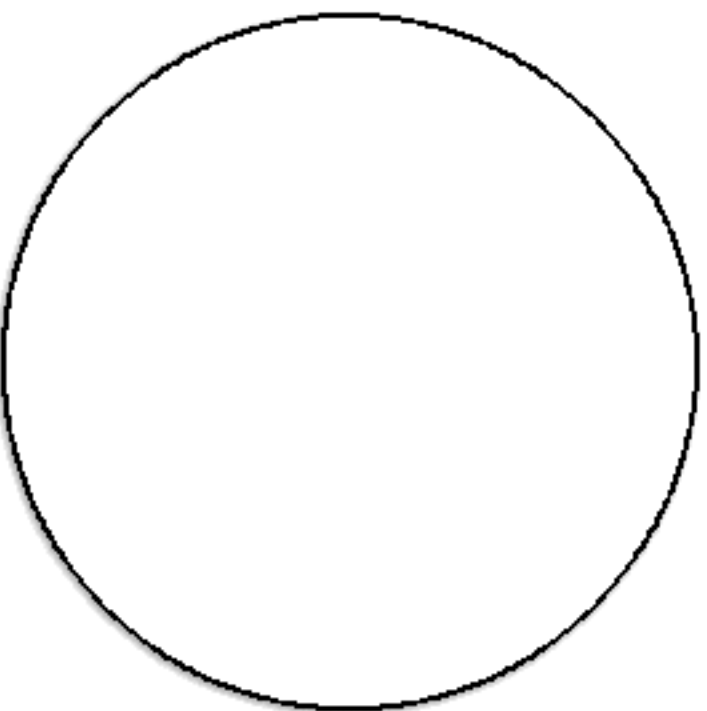

--	--	--	--	--	--	--	--	--	--	--	--	--	--	--	--	--	--	--	--

How many hearts did you find?

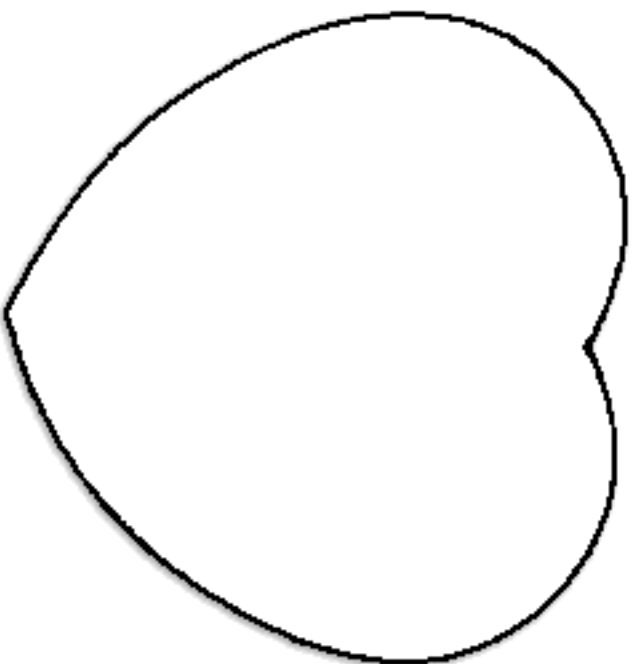

--	--	--	--	--	--	--	--	--	--	--	--	--	--	--	--	--	--	--	--

How many diamonds did you find?

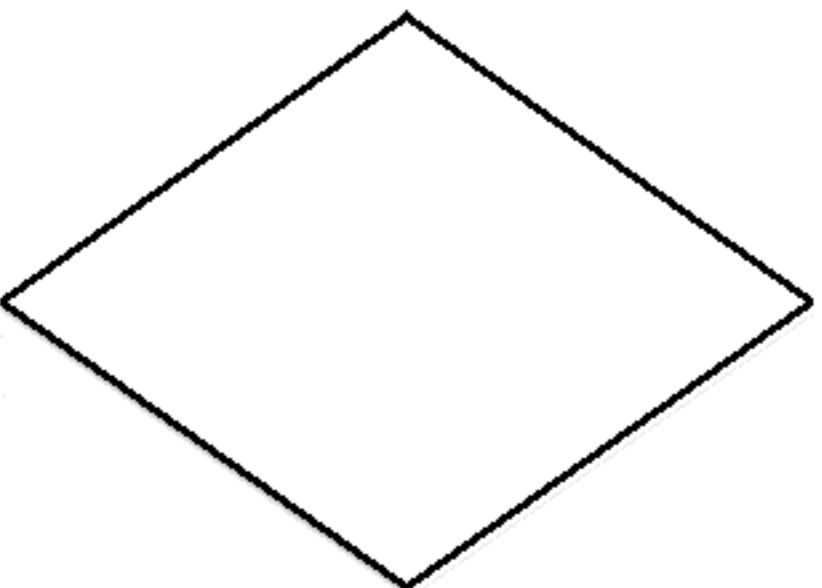

--	--	--	--	--	--	--	--	--	--	--	--	--	--	--	--	--	--	--	--

How many rectangles did you find?

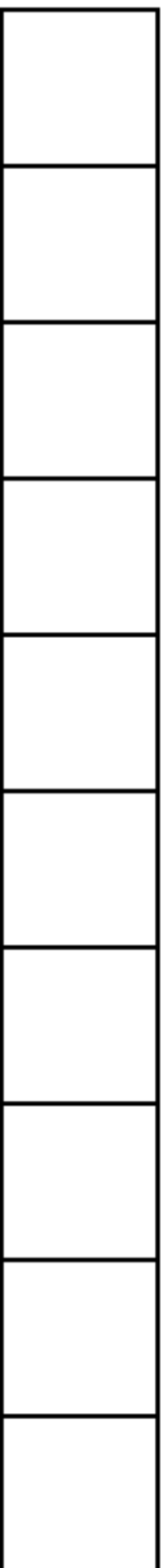
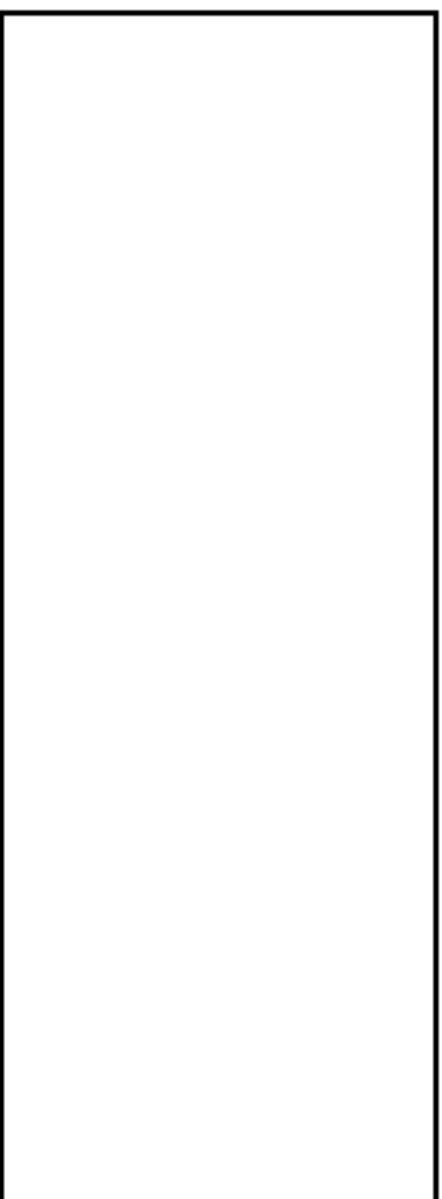

How many squares did you find?

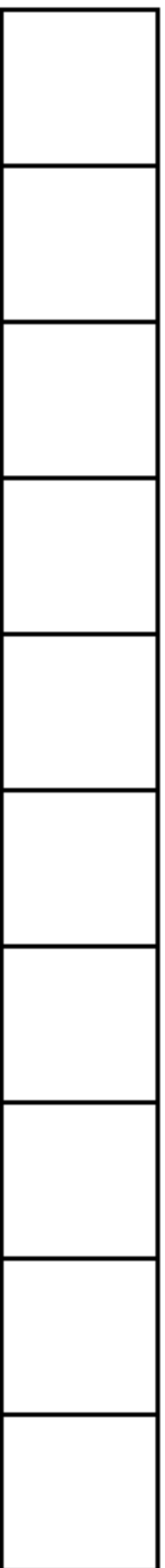
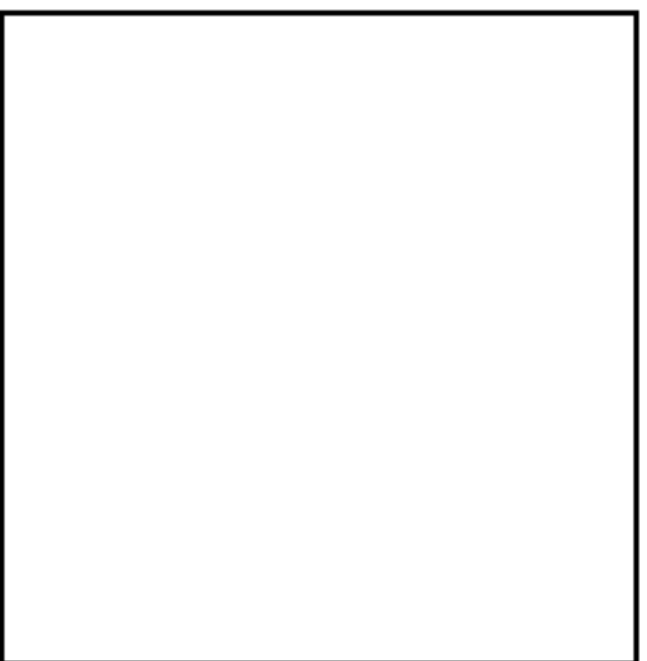

How many triangles did you find?

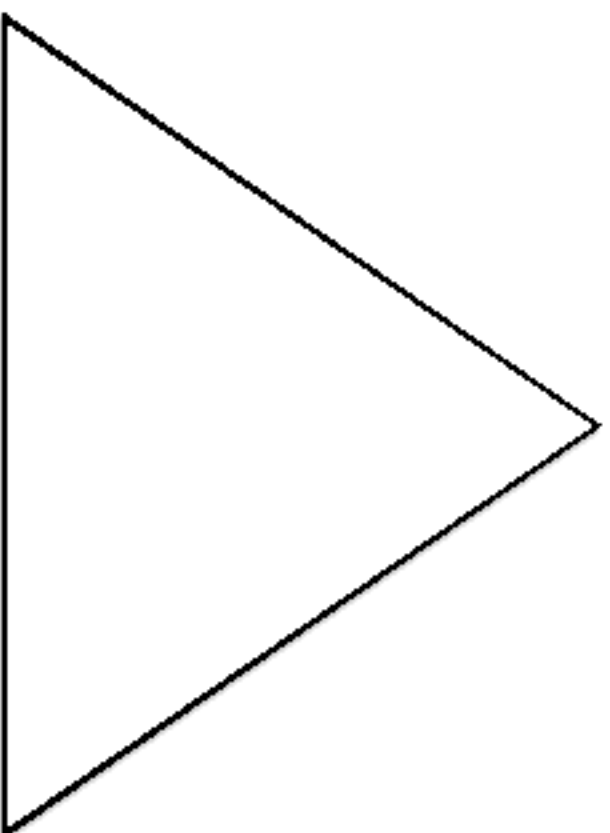

--	--	--	--	--	--	--	--	--	--	--	--	--	--	--	--	--	--	--	--

How many ovals did you find?

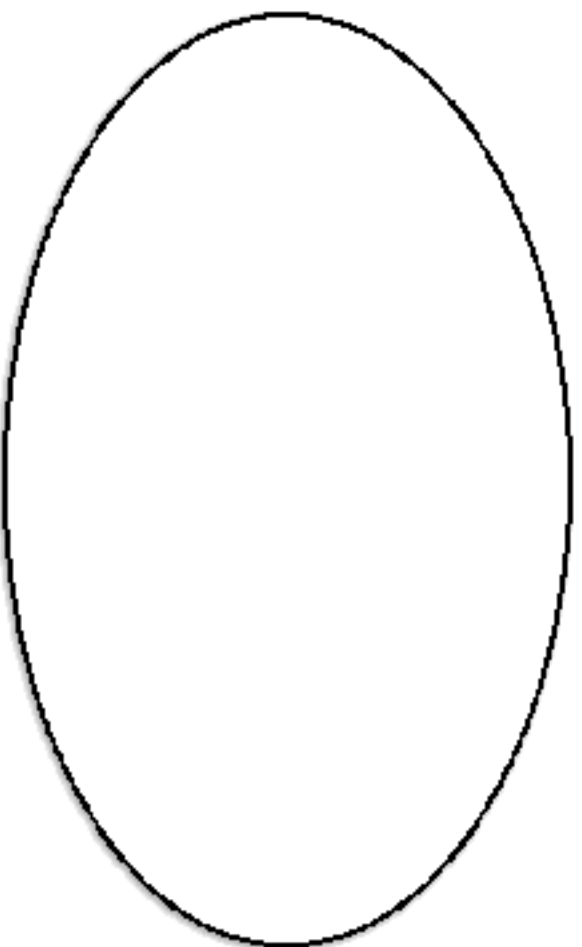

--	--	--	--	--	--	--	--	--	--	--	--	--	--	--	--	--	--	--	--	--

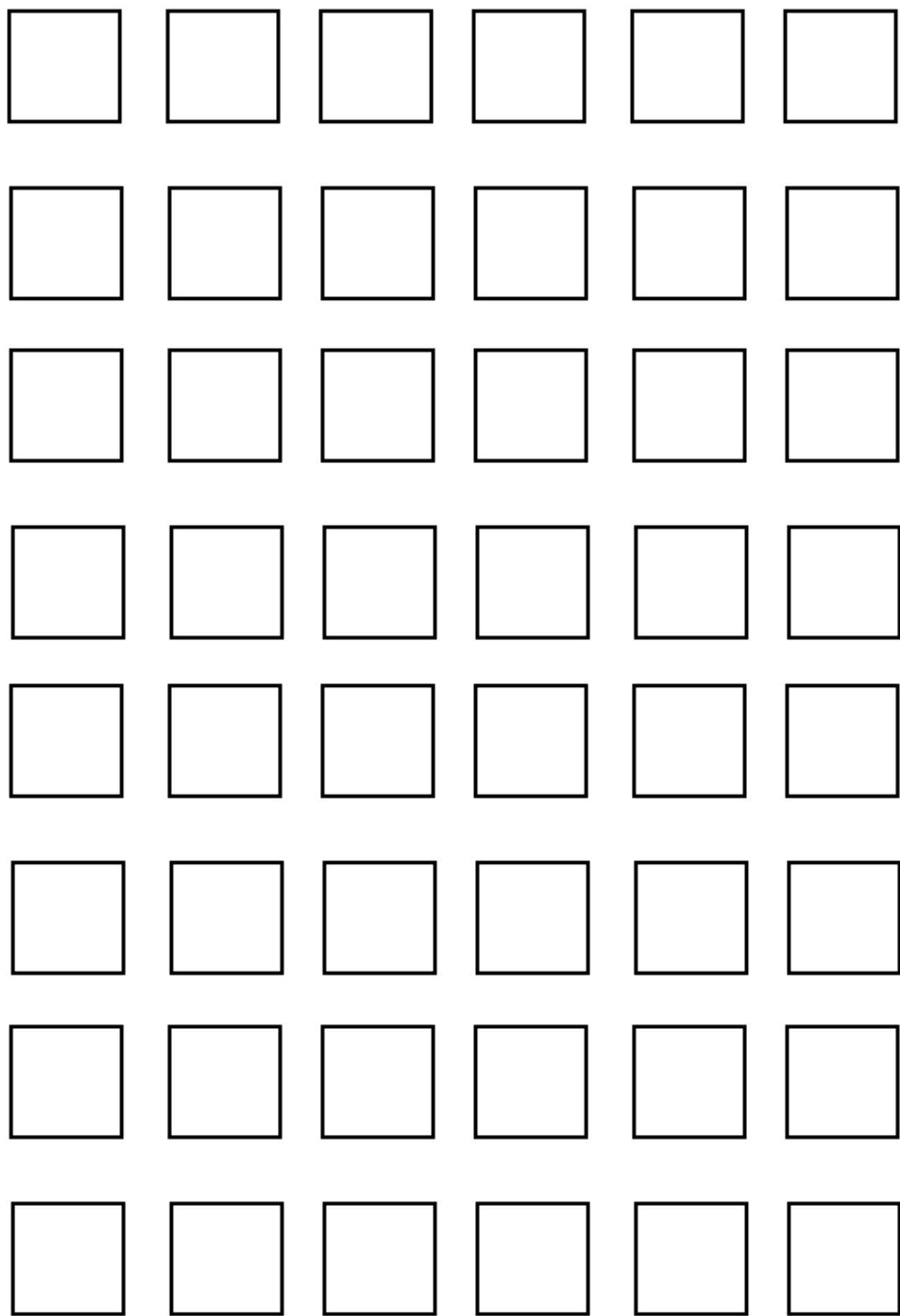

Shape

Find, Count, and Graph

Instructions: Print out as many shape as needed on cardstock paper. Cut out and laminate. Place shapes around room. Give each child a bowl or basket and ask them to find a certain shape. Children search for their shapes and put them in their container. Children then count the number of shapes they found and graph them on the shape graph.