

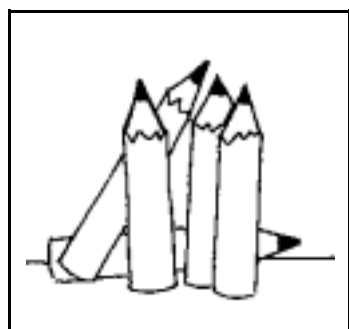

ce ci

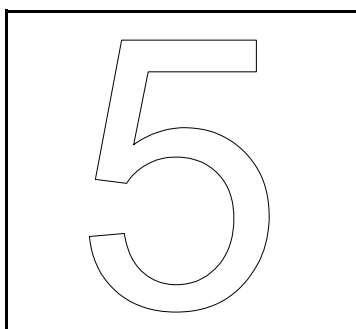

lápices



cinco

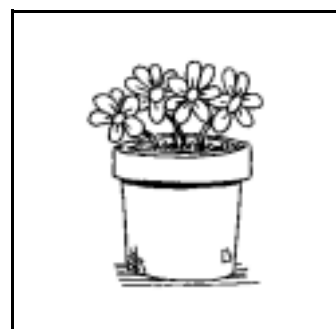

maceta

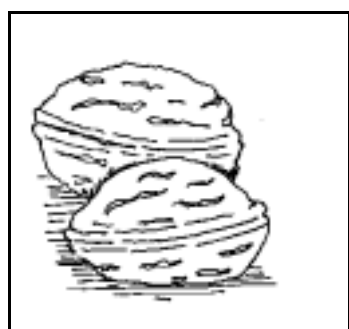

nueces

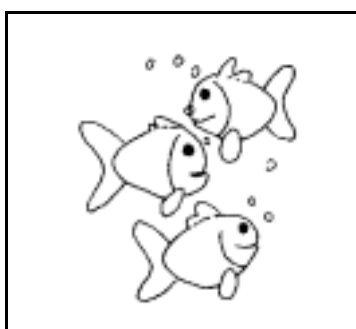

peces



cesta

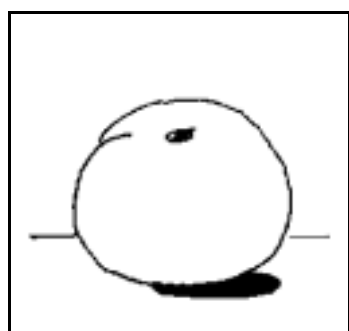

ciruela

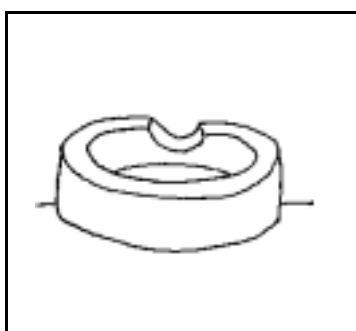

cenicero

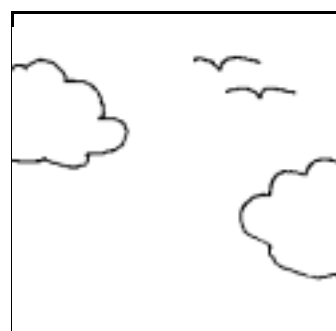

cielo

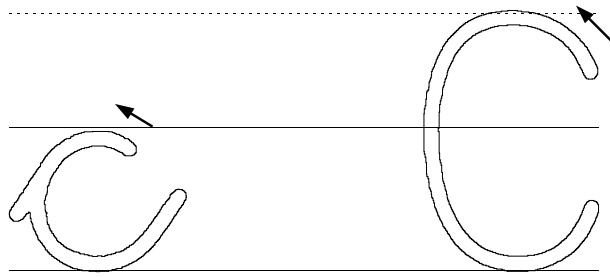

ce ci

Ce Ci

cesto maceta Cecilia Alicia
peces cisne Celia muecas cinco
lápices ciruela cenicero cielo
circo cerdo ciego calcetines.

Una maceta de rosas.

Alicia sale del parque.

Cecilia da comida a los peces.

Alí riega las macetas.

Hua pinta con lápices de
colores un lago con cisnes.

Jaime mira al cielo.



Ce Ci

ce ci

Los lápices de colores

El perro del ciego

El cerdo come ciruelas

Tengo cinco peces en la pecera

En el cesto hay nueces

Me pongo los calcetines

Me gusta mucho el circo chino

Cecilia riega las macetas



En la pecera hay cinco peces.

¿Cuántos peces hay en la pecera?

Alicia tiene ocho lápices.

¿Qué tiene Alicia?

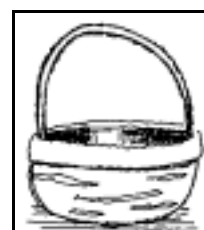
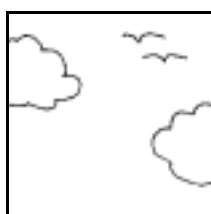
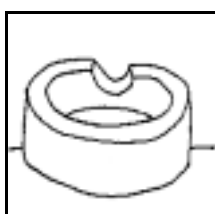
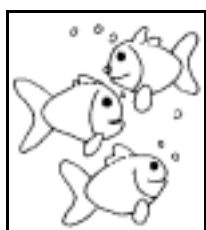
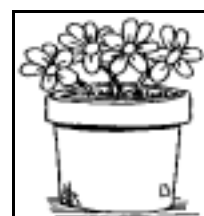
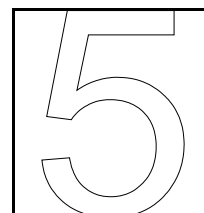
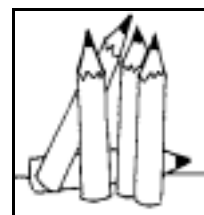
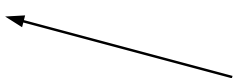

Cecilia
la ciruela
los lápices
el cinco
la maceta
las nueces
los peces
la cesta
el cenicero
el cielo



Cecilia



maceta



peces



lápices



ciruela



cesta



muscos



pecera



cielo



Cecilia riega las macetas

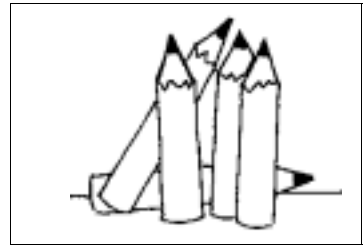

Los lápices de colores

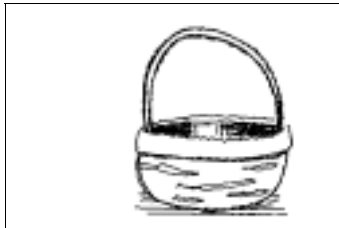

En la cesta hay nueces

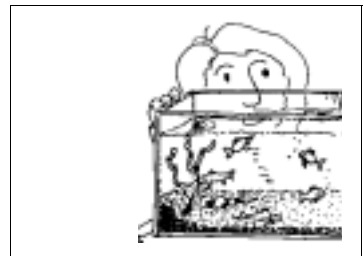

Tengo cinco peces en la pecera



Uno

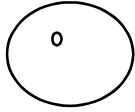

Muchos

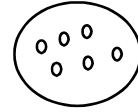

la cesta	las cestas
la maceta	
el cione	
la ciruela	
el cenicero	
el circo	
el cerdo	
el calcetín	
el ciego	

~~cesto~~ colores ciego cerdo camión
maceta cama saco cuna cielo

ce, ci
cesto

ca, co, cu



Leo...

Mi amiga
Cecilia



Ésta es Cecilia

Tiene muchas
macetas

Las riega todos
los días

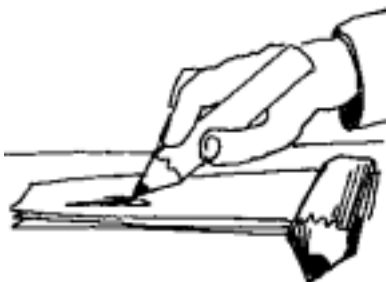

Tiene una
pecera con
cinco peces

Le gusta pintar
con lápices de
colores

Le gustan
mucho las
ciruelas y los
dulces





Una  de margaritas

Cecilia da de comer a los 

En la  hay muchas 

Hua pinta con  de colores

Tengo  ciruelas moradas

Los lápices de colores.
Alicia sale al parque.
Tengo cinco peces en la pecera.
Como ciruelas moradas.
En el cesto hay nueces.
El cerdo come sandías y melones.
El perro del ciego.
Cecilia riega las macetas.



Handwriting practice area consisting of multiple sets of horizontal lines. Each set includes a solid top line, a dashed midline, and a solid bottom line. Two small circles are placed at the beginning of the first two sets of lines.



Tema 21

第二十一课

Unit 21

Mi amiga Cecilia.	我的朋友赛西里亚。	My friend Cecilia.
Ésta es Cecilia.	这是赛西里亚。	This is Cecilia.
Tiene muchas macetas.	他有很多盆花。	She has a lot of flowerpots.
Las riega todos los días.	他每天浇花。	She waters them everyday.
Tiene una pecera con cinco peces.	他有一个鱼缸，里面有五条	She has a fish bowl with five fish in it.
Le gusta pintar con lápices de colores.	他喜欢用彩色笔画。	She likes painting with colored pencils.
Le gustan mucho las ciruelas y los dulces.	他很喜欢吃李子和糖果。	She likes plums and candy a lot.



Los lápices de colores.	彩色笔。	Colored pencils.
Alicia sale al parque.	阿里西亚去公园。	Alicia goes out to the park.
Tengo cinco peces en la pecera.	我有五条鱼，在鱼缸里。	I have five fish in the fish bowl.
Como ciruelas moradas.	我吃紫色的李子。	I am eating purple plums
En el cesto hay nueces.	篮子里有核桃。	There are some walnuts in the basket.
El cerdo come sandías y melones.	猪吃西瓜和哈密瓜。	The pig is eating some watermelon and melon.
El perro del ciego.	导盲犬。	The blind's dog.
Cecilia riega las macetas.	赛西里亚浇花。	Cecilia is watering the flowerpots.
