

quetzal



Quique

qu

Qu

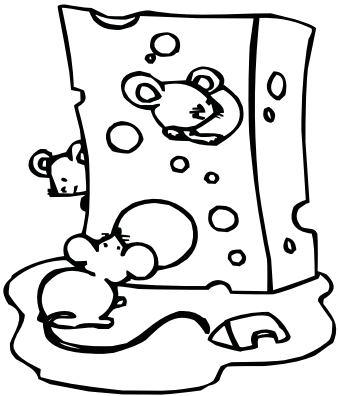

queso



periquito

qu

qu

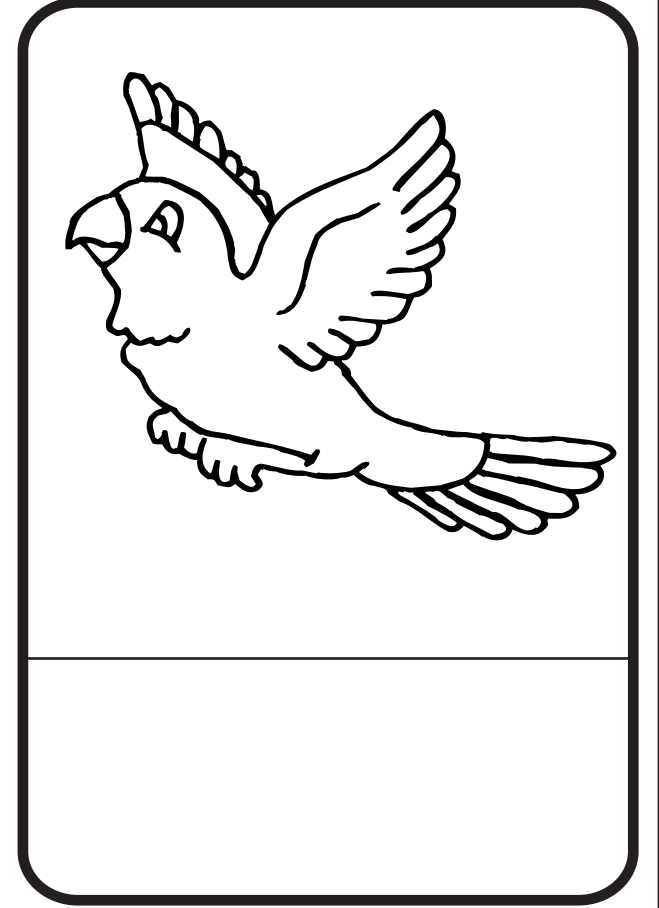
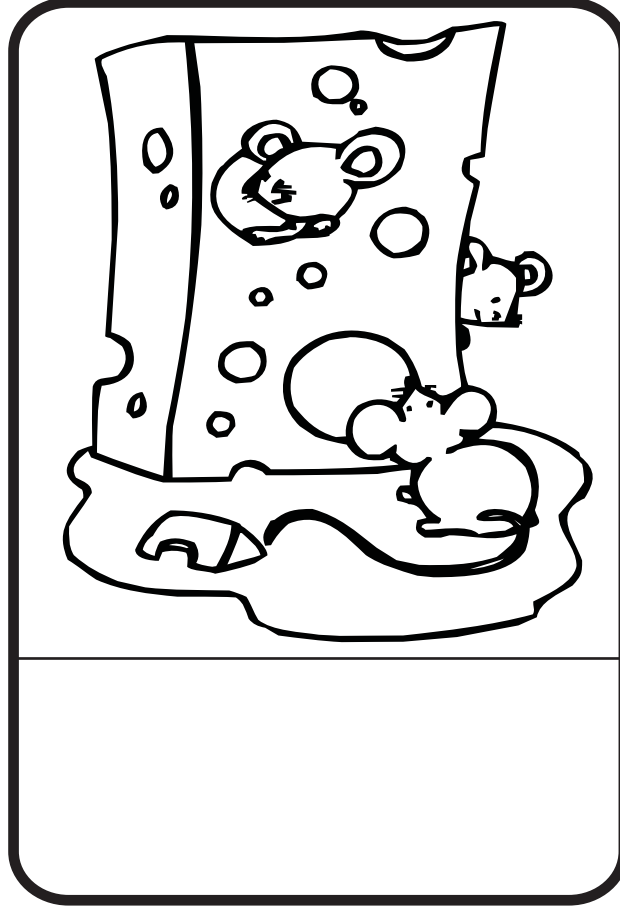
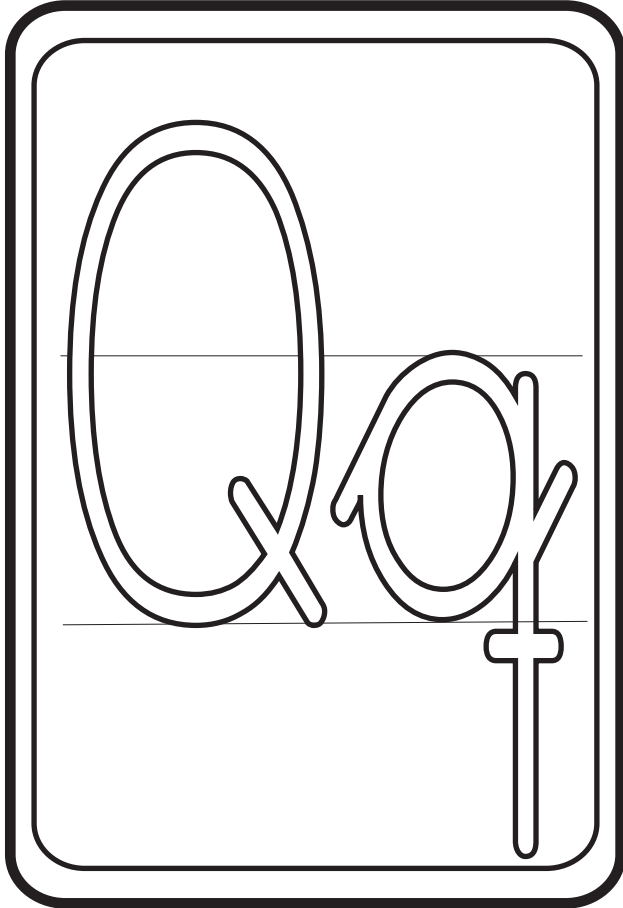

queso

periquito



Presentación letra Q

Técnica: Colorear y repasar con pinturas

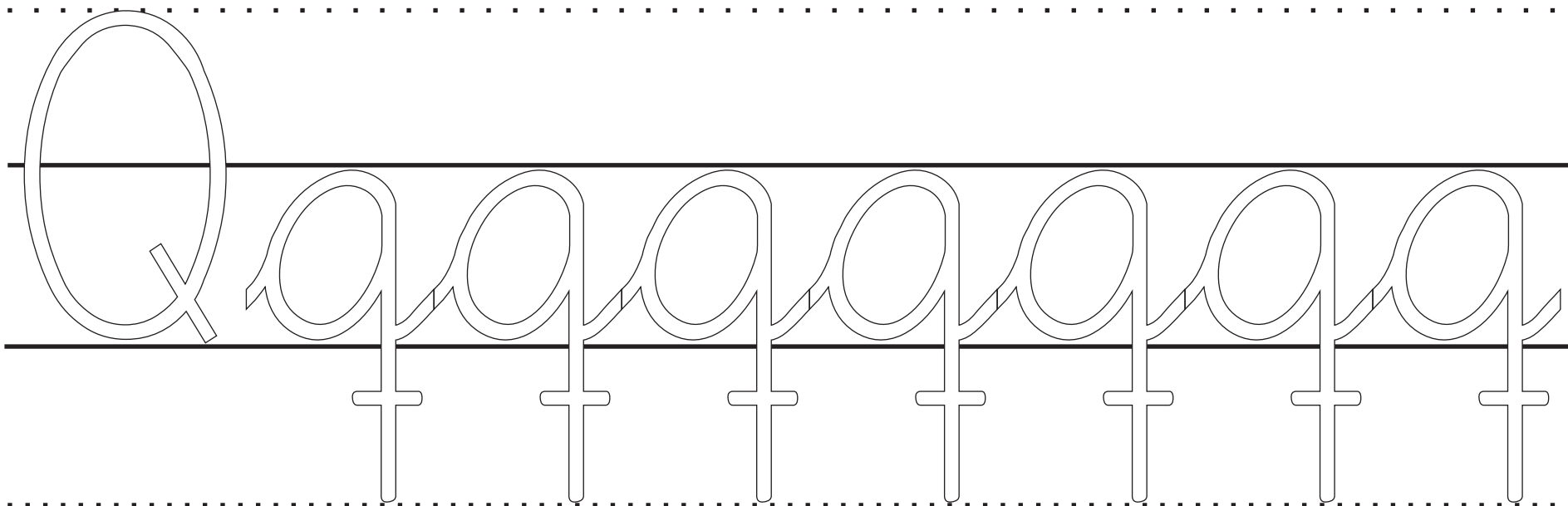
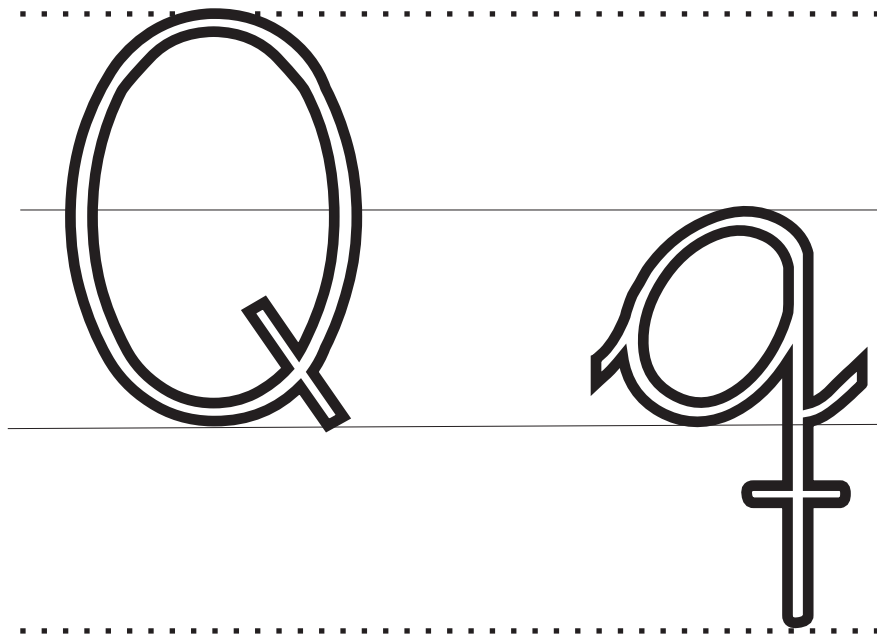
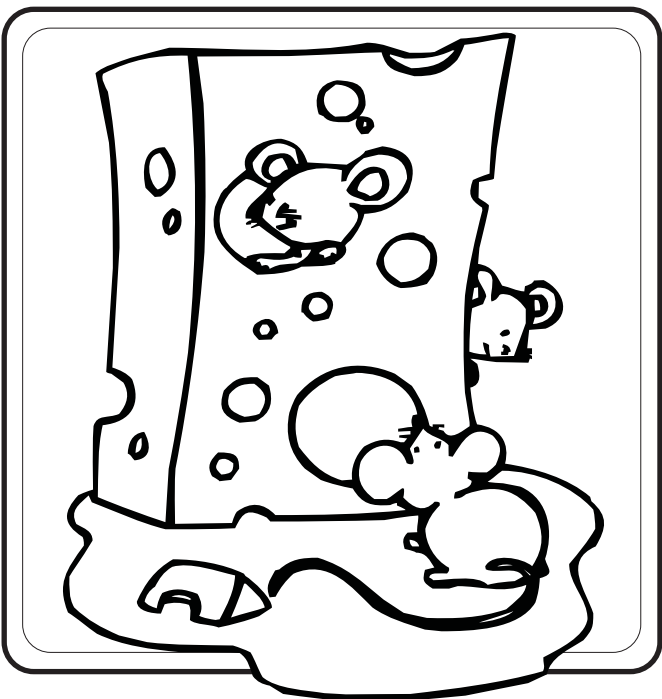



Presentación letra Q

Técnica: Colorear y repasar con pinturas

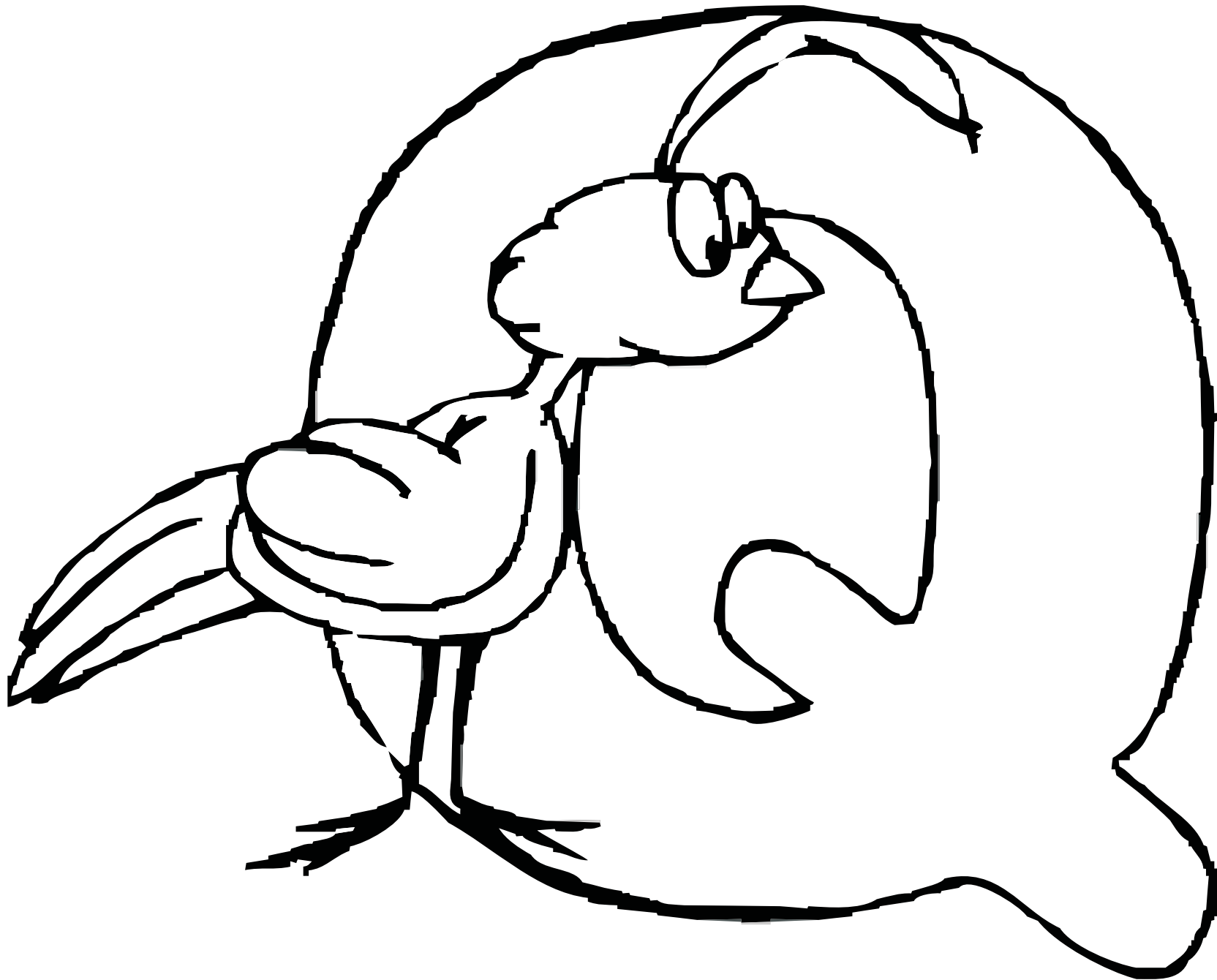



Presentación letra Q

Técnica: Colorear y repasar con pinturas





Percepción auditiva

Técnica: Colorear elementos que tengan la letra Q

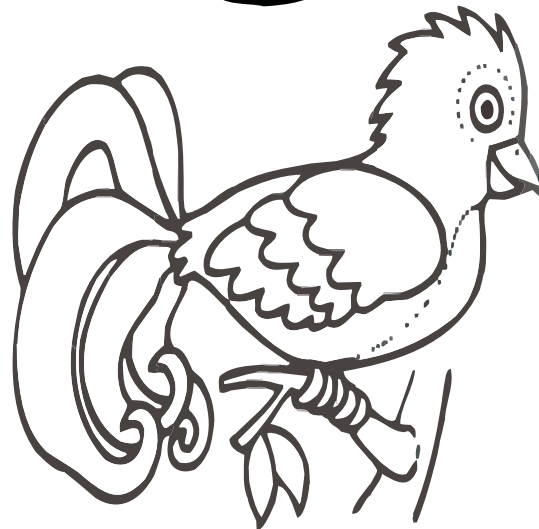
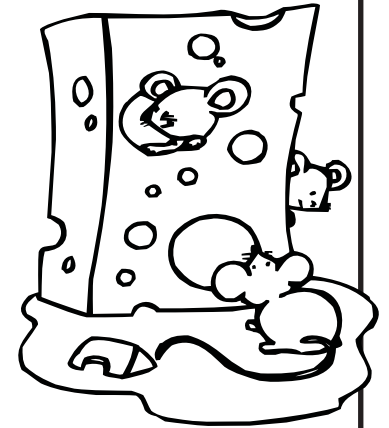
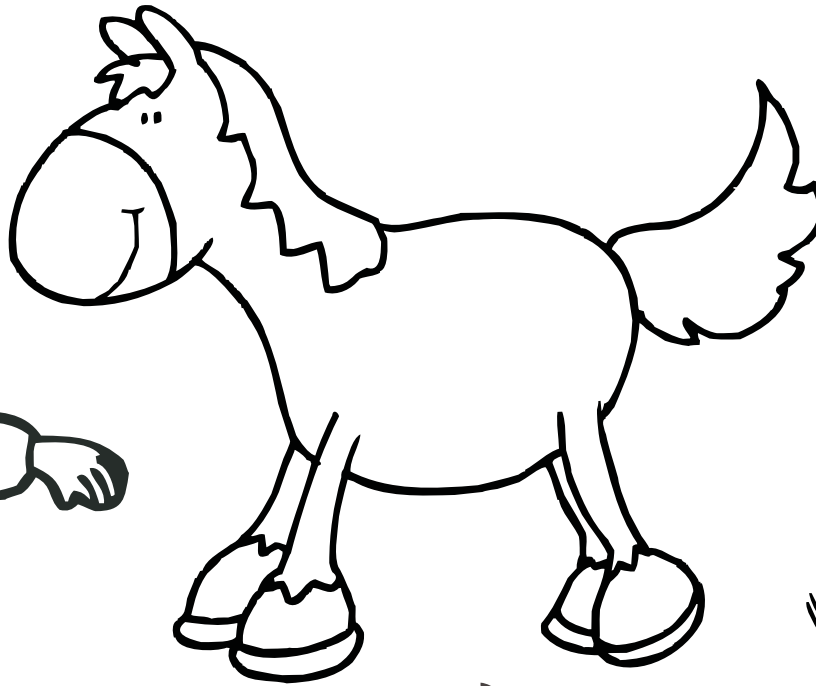
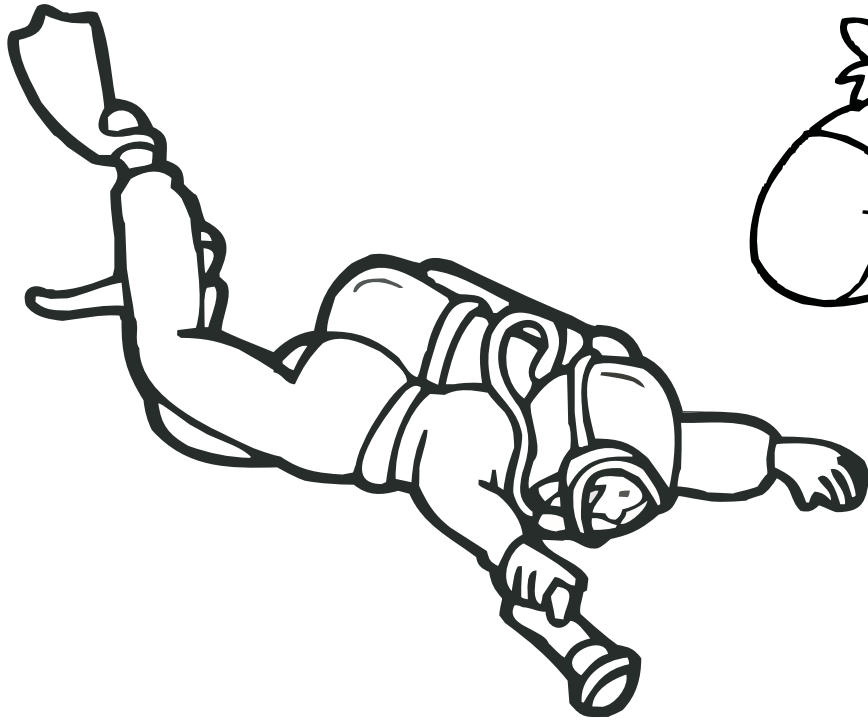



Grafía de la letra Q.  
Técnica: Repasar con pinturas.

